

# E+PLC<sup>400</sup>

## Hardware Reference Guide

Document Number: HA031923/Issue 3  
ECN 32438  
Issue Date: Jan 2015

This page is intentionally blank



## Restriction of Hazardous Substances (RoHS)

Product group E+PLC400

### Table listing restricted substances

Chinese

#### 限制使用材料一览表

产品 E+PLC400	有毒有害物质或元素					
	铅 (Pb)	汞 (Hg)	镉 (Cd)	六价铬 (Cr(VI))	多溴联苯 (PBB)	多溴二苯醚 (PBDE)
IOC	X	○	X	○	○	○
IO 模块	X	○	X	○	○	○
端子模块	X	○	X	○	○	○
基座	X	○	○	○	○	○
○	表示该有毒有害物质在该部件所有均质材料中的含量均在SJ/T11363-2006标准规定的限量要求以下。					
X	表示该有毒有害物质至少在该部件的某一均质材料中的含量超出SJ/T11363-2006标准规定的限量要求。					

English

#### Restricted Materials Table

Product E+400PLC	Toxic and hazardous substances and elements					
	Pb	Hg	Cd	Cr(VI)	PBB	PBDE
IOC	X	○	X	○	○	○
IO Module	X	○	X	○	○	○
Terminal Unit	X	○	X	○	○	○
Base	X	○	○	○	○	○
○	Indicates that this toxic or hazardous substance contained in all of the homogeneous materials for this part is below the limit requirement in SJ/T11363-2006.					
X	Indicates that this toxic or hazardous substance contained in at least one of the homogeneous materials used for this part is above the limit requirement in SJ/T11363-2006.					

Approval

Name:	Position:	Signature:	Date:
-------	-----------	------------	-------

Kevin Shaw

R&D Director

*KShaw*

*7th January 2014*

IA029470U812 Issue 1 Jan 14 (CN31075)

© 2015 Eurotherm Limited

All rights are strictly reserved. No part of this document may be reproduced, modified, or transmitted in any form by any means, nor may it be stored in a retrieval system other than for the purpose to act as an aid in operating the equipment to which the document relates, without the prior, written permission of Eurotherm Limited.

Eurotherm Limited pursues a policy of continuous development and product improvement. The specification in this document may therefore be changed without notice. The information in this document is given in good faith, but is intended for guidance only. Eurotherm Limited will accept no responsibility for any losses arising from errors in this document.

This page is intentionally blank

## Table of Contents

	SAFETY NOTES .....	1
	I/O ISOLATION STRATEGY .....	2
	EMC .....	2
	SYMBOLS USED ON THE INSTRUMENT LABELLING .....	2
<b>1</b>	<b>INTRODUCTION .....</b>	<b>3</b>
	Associated documents .....	3
1.1	PHYSICAL STRUCTURE .....	3
1.2	AVAILABLE I/O MODULES .....	3
1.3	POWER SUPPLY .....	3
<b>2</b>	<b>INSTALLATION .....</b>	<b>4</b>
2.1	UNPACKING THE INSTRUMENT .....	4
2.2	MECHANICAL INSTALLATION .....	5
2.2.1	Backplane mounting .....	8
DIN Rail Mounting .....	8	
Panel Mounting .....	8	
2.2.2	Terminal unit installation .....	9
Terminal Unit Removal .....	9	
2.2.3	Module Installation .....	10
Controller Module .....	10	
I/O Modules .....	10	
2.2.4	Module Removal .....	11
2.2.5	Module identification .....	12
2.3	ELECTRICAL INSTALLATION .....	13
2.3.1	Controller module terminal unit .....	13
Supply Wiring .....	13	
Fuses .....	13	
Wire Sizes .....	14	
Terminal Details .....	14	
Safety Earth .....	14	
Communications Connector .....	15	
USB Connector .....	15	
2.3.2	Hardware Watchdog & Watchdog Relay .....	16
Recovery from a hardware watchdog trigger .....	16	
Watchdog Relay .....	16	
2.3.3	Controller module status indicators .....	17
2.3.4	Two-channel analogue input (AI2) .....	18
Status Indicators .....	19	
2.3.5	Three-channel analogue input (AI3) .....	20
Status Indicators .....	20	
HART Compatibility .....	21	
2.3.6	Four-channel analogue input (AI4) .....	22
Status Indicators .....	23	

2.3.7	High density analogue input (AI8).....	24
	Status indicators .....	26
2.3.8	Two-channel analogue output (AO2).....	27
	Status Indicators .....	28
2.3.9	Six-channel digital input module (DI6).....	29
	Status Indicators .....	29
2.3.10	16-Channel digital output module (DO16) .....	30
	Status indicators .....	31
2.3.11	16-Channel digital input module (DI16).....	32
	Status Indicators .....	32
2.3.12	Eight output relay module (RLY8).....	33
	Status Indicators .....	33
2.3.13	Zirconia input module (ZI).....	34
	Status indicators .....	34
<b>3</b>	<b>CODESYS Software .....</b>	<b>35</b>
3.1	Accessing the CODESYS Online Help.....	35
3.2	CODESYS Library Documentation.....	36
3.3	'How to' tutorial videos and example projects .....	37
<b>Appendix A:</b>	<b>SPECIFICATION .....</b>	<b>39</b>
A1	INSTALLATION CATEGORY AND POLLUTION DEGREE.....	39
A2	GENERAL SPECIFICATION .....	39
A2.1	Physical .....	39
A2.2	Electrical .....	39
A2.3	Environmental.....	40
A2.4	Approvals.....	40
A2.5	Ethernet Communications .....	41
A2.6	Modbus Communications .....	41
A3	CONTROLLER MODULE SPECIFICATION .....	42
A3.1	TERMINAL UNIT .....	42
A3.1.1	Physical .....	42
A3.1.2	Setup Switch .....	42
A3.1.3	Link.....	42
A3.1.4	User Connectors .....	42
A3.1.5	USB .....	42
A3.2	CONTROLLER MODULE HARDWARE.....	43
A3.2.1	General.....	43
A3.2.2	LED Indicators.....	43
A3.2.3	User Connections.....	43
A3.2.4	Removable Storage.....	43
A4	I/O MODULE SPECIFICATIONS.....	44
A4.1	AI2 MODULE.....	44
	General specification, common to all variants: .....	44
A4.1.1	Thermocouple input variant, AI2-TC .....	44
	mV inputs, Thermocouple inputs .....	44
	Cold Junction .....	44

High impedance input (channel two only) .....	44
A4.1.2 DC input variant, AI2-DC .....	45
mV inputs .....	45
High impedance input (channel two only) .....	45
Voltage inputs .....	45
Resistance inputs .....	45
High Resistance input .....	46
Potentiometer inputs .....	46
A4.1.3 mA input variant, AI2-MA .....	46
4 to 20 mA loop inputs .....	46
A4.2 AI3 MODULE .....	47
A4.2.1 General specification .....	47
A4.2.2 Hart Compliance .....	47
A4.2.3 Channel inputs .....	47
A4.3 AI4 MODULE .....	48
General specification (applies to all AI4 variants) .....	48
A4.3.1 Thermocouple input variant .....	48
Thermocouple inputs .....	48
Cold Junction .....	48
A4.3.2 mV input variant .....	48
A4.3.3 mA input variant .....	49
A4.4 AI8 MODULE .....	50
General specification (applies to all AI8 variants) .....	50
A4.4.1 Thermocouple input variant .....	50
Thermocouple inputs .....	50
Cold Junction .....	50
A4.4.2 mV input variant .....	50
A4.4.3 mA input variant .....	51
A4.4.4 RTD input variant .....	51
A4.5 AO2 MODULE .....	52
A4.5.1 General specification .....	52
A4.5.2 Current outputs .....	52
A4.5.3 Voltage outputs .....	52
A4.6 DI6 MODULE .....	53
General specification .....	53
A4.6.1 115V ac input variant: 115V inputst .....	53
A4.6.2 230V ac input variant: 230V inputs .....	53
A4.7 DI 16 MODULE .....	54
A4.7.1 General specification .....	54
A4.7.2 Logic inputs .....	54
A4.7.3 Contact inputs .....	54
A4.8 DO16 MODULE .....	55
A4.8.1 General specification .....	55
A4.8.2 Output specification .....	55
A4.9 RLY8 MODULE .....	56
A4.9.1 General specification .....	56
A4.9.2 Relay specification .....	56
A4.10 ZI Zirconia Input Module .....	57

---

A4.10.1	General specification.....	57
A4.10.2	Thermocouple input (channel 1).....	57
	Cold Junction .....	57
A4.10.3	Zirconia input (channel 2).....	57
Appendix B:	E+PLC400 Battery Replacement Procedure .....	59
Appendix C:	E+HMI150 Panel Configuration .....	63
C1	Connections.....	63
C2	Procedure .....	63
C3	Set up the IP address .....	64
C4	Import/Export 'RemoteVisu' Configuration file to/from the E+HMI150.....	64
	C4.1 Preparing a USB memory stick .....	64
	C4.2 Carrying out the Import/export process .....	64



## List of Figures

Figure 1:	Overall dimensions .....	5
Figure 2:	Fixing details (including safety earth connection) .....	6
Figure 3:	Zero-module backplane dimensions .....	7
Figure 4:	Terminal unit installation/removal .....	9
Figure 5:	Controller module installation .....	10
Figure 6:	I/O Module installation .....	11
Figure 7:	Inside cover .....	12
Figure 8:	Controller module terminal unit wiring; watchdog relay terminals .....	13
Figure 9:	RJ45 plug (view on underside) .....	15
Figure 10:	Controller module LEDs .....	17
Figure 11:	AI2 module pinout .....	18
Figure 12:	AI2 Status indicators .....	19
Figure 13:	AI3 module pinout .....	20
Figure 14:	AI3 Status indicators .....	20
Figure 15:	AI3 module equivalent circuit .....	21
Figure 16:	Link locations on underside of terminal unit .....	21
Figure 17:	AI4 module pinout .....	22
Figure 18:	AI4 status indicators .....	23
Figure 19:	AI8-RT terminal unit .....	24
Figure 20:	AI8-MA and AI8-FMA terminal units .....	24
Figure 21:	AI8-TC terminal units .....	25
Figure 22:	AI8 module status .....	26
Figure 23:	AO2 module pinout .....	27
Figure 24:	AO2 module status indicators .....	28
Figure 25:	DI6 module pinout & status indicators (230V version shown; 115V version similar) .....	29
Figure 26:	DO16 module pinout .....	30
Figure 27:	DO16 module status LEDs .....	31
Figure 28:	DI16 module pinout .....	32
Figure 29:	DI16 module status indicators .....	32
Figure 30:	RLY8 module pinout .....	33
Figure 31:	RLY8 status indicators .....	33
Figure 32:	ZI Module pinout .....	34
Figure 33:	Zirconia module LEDs .....	34
Figure 34:	Launching the CODESYS online help .....	35
Figure 35:	The CODESYS Online Help viewer .....	35
Figure 36:	Viewing library documentation in the CODESYS Library Manager .....	36
Figure 37:	Accessing the Eurotherm web portal from within the CODESYS Development System .....	37
Figure 38:	E+PLC400 Humidity tolerance .....	40
Figure 39:	Battery board in place .....	60
Figure 40:	Battery board removed .....	61
Figure 41:	New battery board .....	62
Figure 42:	Example E+HMI150 panel connection .....	63
Figure 43:	System Settings tool .....	63
Figure 44:	Example CodesysControl.cfg .....	65

This page is intentionally blank

## SAFETY NOTES



**Warning:** Any interruption of the protective conductor inside or outside the apparatus, or disconnection of the protective earth terminal is likely to make the apparatus dangerous under some fault conditions. Intentional interruption is prohibited.



Note: in order to comply with the requirements of safety standard BS EN61010-1, the instrument shall have one of the following as a disconnecting device, fitted within easy reach of the operator, and labelled as the disconnecting device.

- (a) A switch or circuit breaker which complies with the requirements of IEC947-1 and IEC947-3
- (b) A separable coupler which can be disconnected without the use of a tool.
- (c) A separable plug, without a locking device, to mate with a socket outlet in the building.



Note: Under extreme shock along the axis of the backplane, the E+PLC400 controller module is liable to reset. Following this reset, the behaviour of the instrument depends on the Watchdog Retry configuration switch on the terminal unit ([section 2.3.1](#)), which controls whether the instrument is allowed to reboot.

1. Before any other connection is made, the protective earth terminal shall be connected to a protective conductor. The mains (supply voltage) wiring to the PSU must be terminated in such a way that, should it slip, the earth wire would be the last wire to become disconnected.
2. The protective earth terminal must remain connected (even if the equipment is isolated from the mains supply), if any of the I/O circuits are connected to hazardous voltages<sup>1</sup>.
3. Fuses are not user replaceable. If it is suspected that the fuse is faulty, the manufacturer's local service centre should be contacted for advice.
4. Whenever it is likely that protection has been impaired, the unit shall be made inoperative, and secured against accidental operation. The manufacturer's nearest service centre should be contacted for advice.
5. Any adjustment, maintenance and repair of the opened apparatus under voltage, should be avoided as far as possible and, if inevitable, shall be carried out only by a skilled person who is aware of the hazard involved.
6. Where conductive pollution (e.g. condensation, carbon dust) is likely, adequate air conditioning/filtering/sealing etc. must be installed in the E+PLC400 enclosure.
7. If the equipment is used in a manner not specified by the manufacturer, the protection provided by the equipment might be impaired.
8. In order to comply with the requirements of BS EN61010-1 the voltage applied across I/O terminals may not exceed the isolation voltage for those terminals. For terminals specified as having 'no isolation', the maximum permissible voltage is 30V ac or 60V dc.
9. Over temperature protection: A separate over-temperature protection unit (with an independent temperature sensor) should be fitted to isolate any process heating circuit should a fault condition arise. Alarm relays within the instrument do not give protection under all fault conditions.

1. A full definition of 'Hazardous' voltages appears under 'Hazardous live' in BS EN61010-1. Briefly, under normal operating conditions, hazardous voltages are defined as being > 42.2 V peak ac (30 V RMS) or > 60 V dc

## I/O ISOLATION STRATEGY

Isolation is implemented in the form of a double insulation (300V) barrier separating all the I/O channels in a module from the rest of the system. This prevents hazardous voltages on any one I/O channel from introducing hazards on wiring associated with any other I/O module, or from putting the rest of the system at risk.

Modules which provide channel-to-channel isolation further ensure safety and good signal quality on all channels within such modules. Refer to the relevant section of [Appendix A](#): for more details.

## EMC

This instrument conforms with the essential protection requirements of the EMC Directive 2004/108/EC. It also satisfies the emissions and immunity standards for industrial environments.

To ensure compliance with the European EMC directive certain installation precautions are necessary:

- **Relay outputs:** When using relay outputs it may be necessary to fit a filter suitable for suppressing conducted emissions. The filter requirements will depend on the type of load.
- **Routing of wires:** To minimise the pick-up of electrical noise, low voltage DC connections and sensor input wiring should be routed away from high-current power cables. Where it is impractical to do this, shielded cables should be used.
- **Power supply:** The instrument must be powered from a local power supply and must not be connected to a DC distribution network. The power supply must be earthed according to manufacturers instructions in order to give best EMC performance for the system.

## SYMBOLS USED ON THE INSTRUMENT LABELLING

One or more of the symbols below may appear either as a part of the labelling of the items comprising this instrument. In some cases, symbols may be incorporated in the moulding or stamped on the metalwork.









Symbol	Meaning
	Refer to the user guide for instructions.
	Protective conductor terminal (safety earth).
	Precautions against electrostatic discharge must be taken before handling this unit or any electronic component of it.
	Complies with the RoHS2 (2011/65/EU) directive.
	For environmental reasons, this product must be recycled before its age exceeds the number of years shown in the circle.
	Underwriters Laboratories listed mark for the United States and Canada.
	This unit is CE compliant.
	This unit is ACMA compliant.
	Risk of electric shock.

Table 1: Symbols used on the E+PLC400

## 1 INTRODUCTION

This document describes the installation and configuration of the E+PLC400 hardware components. The instrument supports up to 16 I/O modules (according to backplane size) and is equipped for secure archiving via FTP transfer and/or to USB memory stick.

### Associated documents

- HA031793 E+PLC400 Installation & Wiring Instructions sheet
- IA029470U812 Declaration of conformity

Online help is also available within the CODESYS software, see [Section 3](#)

### 1.1 PHYSICAL STRUCTURE

The E+PLC400 hardware consists of a Controller module and up to 16 Input/Output (I/O) Modules each of which clips into its own individual terminal unit which provides termination for user wiring. The terminal units themselves are located in a backplane which is mounted on a DIN rail or on a panel, as required. Backplanes are available in different sizes to accommodate different numbers of I/O Modules: with 16, 8, 4 or 0 slots (the latter accommodating a Controller module only).

The lower front of the unit is covered by a removable flap which protects the wiring, but leaves the status LED open to view.

Live replacement of a failed control module can be carried out, without wiring disconnections. Full hardware and software status indication allows rapid verification and diagnostics.

Automatic health checks, self-testing, and initialisation are carried out at power-up. I/O status and external communications are checked continuously and LEDs are provided on all modules to indicate communications and module I/O status.

### 1.2 AVAILABLE I/O MODULES

AI2	Two isolated universal analogue input channels. Terminal unit variants are available for particular applications (thermocouple inputs, resistance thermometer inputs, voltage or current measurement).
AI3	Three analogue input channels used for current loops, either self powered or externally powered.
AI4	Two pairs of isolated analogue input channels. Terminal unit variants are available for particular applications (thermocouples, mA or mV inputs).
AI8	High density analogue input module. Terminal unit variants are available for eight channels of mA inputs (fast or standard polling), eight channels of thermocouples with cold junction compensation (also accepts mV inputs), or four channels for platinum resistance thermometers (RTD).
AO2	Two analogue output channels supplying 0 to 20mA or 0 to 10V signals.
DI6	Six channel digital input module. Supplied in 115V or 230V a.c. mains input variants.
DI16	16 digital input channels (universal inputs).
DO16	16 digital output channels.
RLY8	Eight relays (normally open).
ZI	Zirconia probe input.

### 1.3 POWER SUPPLY

Power is applied to terminals mounted on the controller module, as shown in [section 2.3.1](#). The system monitors the supply voltage allowing an alarms to be triggered should the supply voltage drop below an acceptable value.

## **2 INSTALLATION**

### **2.1 UNPACKING THE INSTRUMENT**

The instrument is despatched in a special pack, designed to give adequate protection during transit. Should the outer box show signs of damage, it should be opened immediately, and the contents examined. If there is evidence of damage, the instrument should not be operated and the local representative contacted for instructions. After the instrument has been removed from its packing, the packing should be examined to ensure that all accessories and documentation have been removed. The packing should then be stored against future transport requirements.

## 2.2 MECHANICAL INSTALLATION

Figure 1 and Table 2 give dimensional details for the E+PLC400; Figure 2 gives fixing details. Figure 3 shows details for instruments with a zero-module backplane.

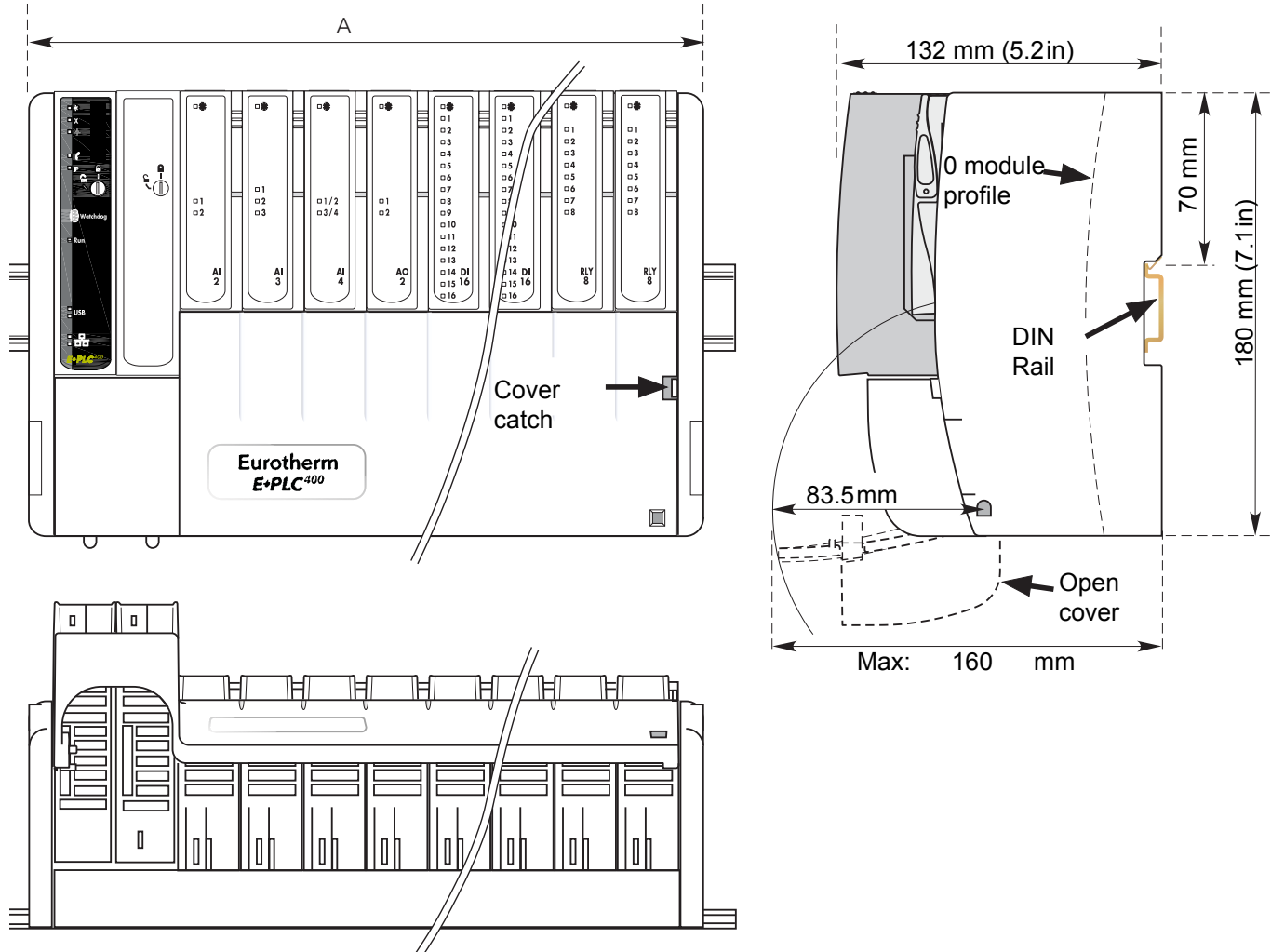

Figure 1: Overall dimensions

Backplane size	Length of 'A' (figure 1)	
	mm	in
0 module	71.0	2.8
4 module	172.5	6.8
8 module	274.0	10.8
16 module	477.0	18.8

Table 2: E+PLC400 backplane dimensions

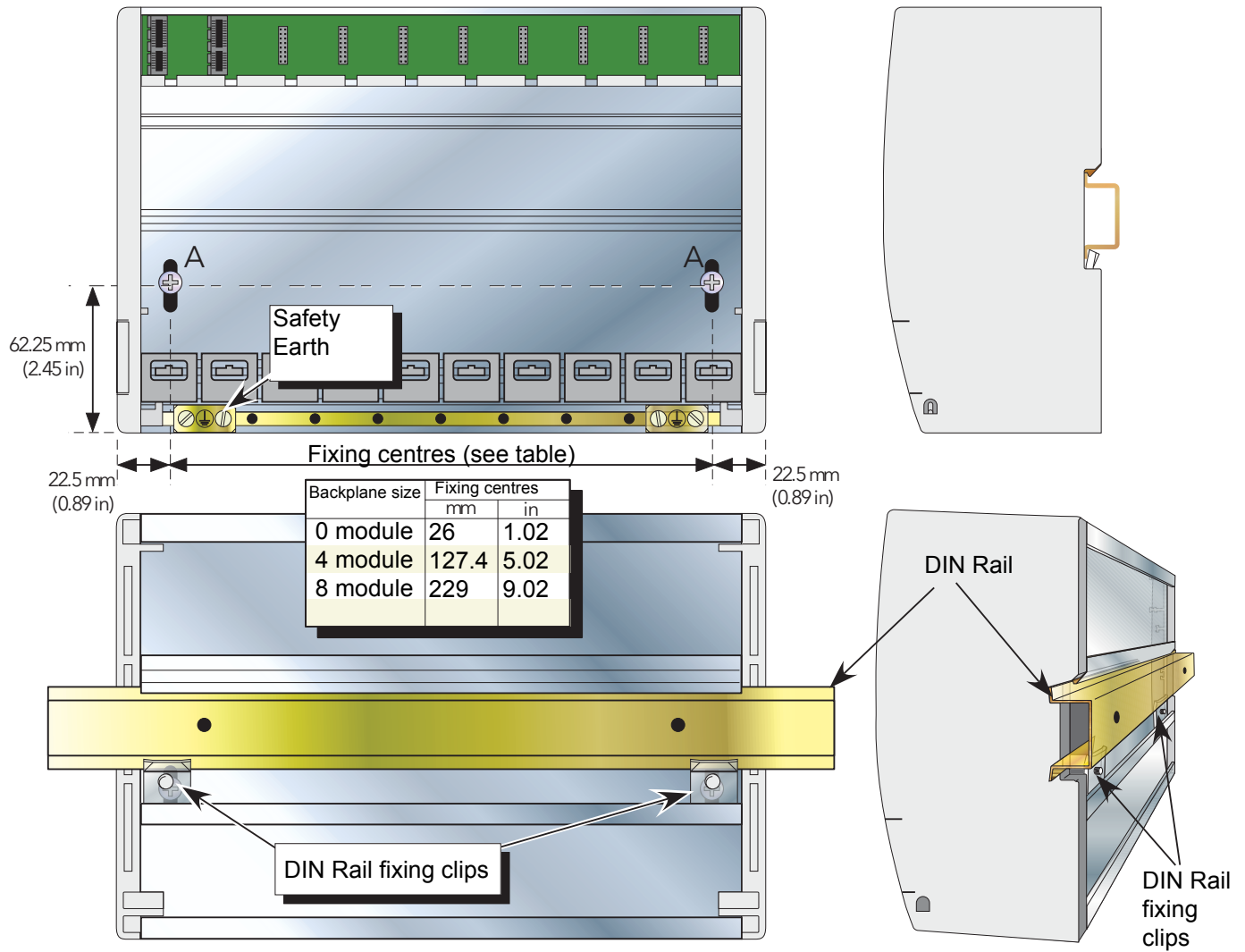

Figure 2: Fixing details (including safety earth connection)



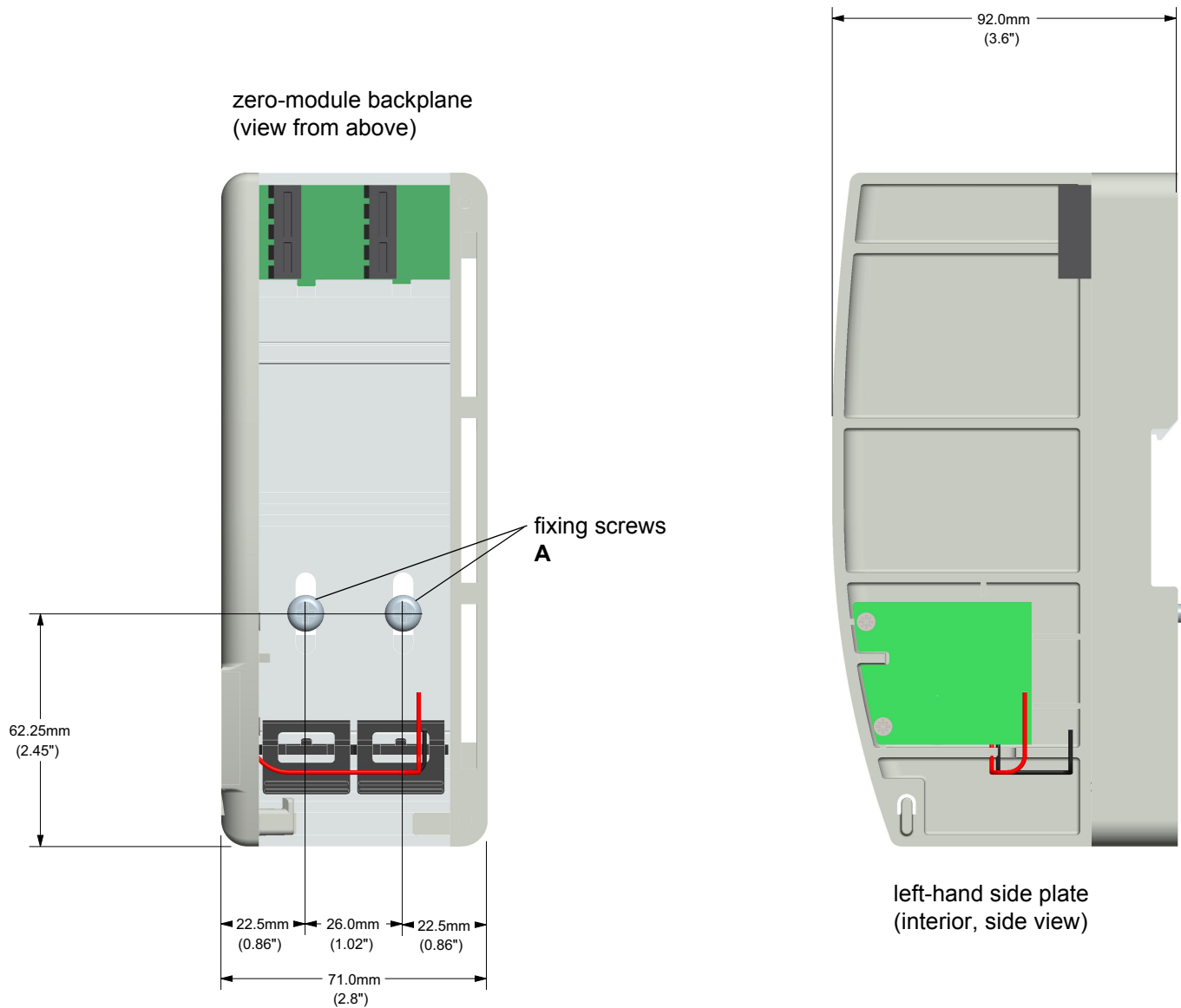

Figure 3: Zero-module backplane dimensions

For 0-module backplanes, the instrument is supplied without the right-hand plastic side plate fitted. The side plate is included in the packaging and can be fitted if desired.

## 2.2.1 Backplane mounting

This backplane is intended for DIN rail or bulkhead mounting within an enclosure.



**Warning:** The equipment should not be operated without a protective earth conductor connected to one of the earth terminals on the backplane. The earth cable should have at least the current rating of the largest power cable used to connect to the instrument.

The protective earth cable should be terminated with a suitable tinned copper eyelet, retained by one of the screw and washer supplied with the base unit, tightened to a torque of 1.2 Nm (10.5 lb in).

This connection also provides a ground for EMC purposes.

### DIN Rail Mounting

For DIN rail mounting, symmetrical, horizontally-mounted 35×7.5mm or 35×15mm DIN rail to BS EN50022 should be used.

1. Mount the DIN rail, using suitable bolts, ensuring that it makes good electrical contact with the enclosure metal work either *via* the bolts or by means of a suitable earthing cable.
2. Loosen the screws ('A' in [Figure 2](#) and [Figure 3](#)) in the backplane, two or three turns, and allow them, and the associated fixing clips to slide to the bottom of the screw slot.
3. Lower the backplane on to the DIN rail such that the top edge of the rail fits into the slot on the underside of the support bar (see [Figure 2](#) and [Figure 3](#)).
4. Slide the screws (A) and associated clips as far as they will go towards the top of the screw slots, ensuring that the top of each fixing clip locates behind the bottom edge of the DIN rail.
5. Tighten the screws, and check that the base unit is fully secure on the rail.

### Panel Mounting



**Warning:** Bolt heads must not exceed 5mm in height, or there will be insufficient isolation clearance between the bolt head and the relevant terminal unit(s).

1. Remove the screws ('A' in [Figure 2](#) and [Figure 3](#)) and associated fixing clips.
2. Holding the base unit horizontally on the panel, mark the position of the two holes on the panel.
3. Drill two suitable holes in the panel, and use two suitable bolts (M5 recommended) to secure the backplane to the panel, ensuring that good electrical contact with the enclosure metal work is made either *via* the bolts or by means of a suitable earthing cable.

## 2.2.2 Terminal unit installation

1. Insert the tag at the top of the terminal unit printed circuit board into the relevant slot in backplane (action 'B' in [Figure 4](#)).
2. Press on the bottom of the terminal unit until a 'click' confirms that the retention clip has sprung back into position to secure the terminal unit (action 'C' in [Figure 4](#)).



**Caution:** Ensure that the correct terminal unit is used for the type of I/O Module being fitted. In particular, fitting an AI2 module to an AI4 terminal unit, or vice-versa, causes unexpected behaviour which may damage the process being controlled.



**Note:** If the backplane is not fully populated a blank terminal unit (supplied) must be fitted immediately to the right of the final module position in order to maintain IP20 rating

### Terminal Unit Removal

1. Remove the terminal unit's I/O module, if fitted ([section 2.2.3](#), below).
2. If necessary, remove all wiring from the terminal unit.
3. Press the retention clip at the bottom of the terminal unit and lift the terminal unit out (action 'D' in [Figure 4](#)).

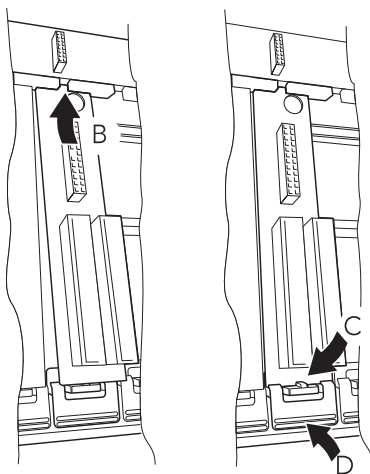

Figure 4: Terminal unit installation/removal

## 2.2.3 Module Installation

### Controller Module

The controller module (Figure ) is installed in the left-most slot only.

A blank case is fitted in the adjacent slot—this slot is not intended for controller module use..

To install an controller module:

1. Use a 3mm flat-blade screwdriver to ensure that the securing bolt is rotated anti-clockwise (counter clockwise) to the unlocked position.
2. Offer the module up to the terminal unit and the backplane, and push home.
3. Use a 3mm flat-blade screwdriver to rotate the securing bolt 90° clockwise to the locked position.

To remove an controller module:

1. Use a 3mm flat-blade screwdriver to rotate the securing bolt 90° anti-clockwise (counter clockwise) to the unlocked position.
2. Disengage the module and lift it out of the base unit.

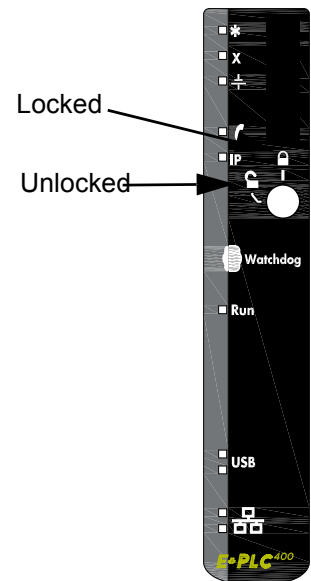

Figure 5: Controller module installation



Note: Whilst the I/O cover flap on 4/8/16-way units may be removed to ease access to terminal units, the side pieces must be left in place to provide support and to guide insertion.

### I/O Modules

1. Pull the module retaining lever forwards into the unlocked position as shown in Figure 6.
2. Offer the module up to the terminal unit and the backplane, and push home.
3. Return the retaining lever to the locked position.



**Caution:** Ensure that the correct terminal unit is used for the type of I/O Module being fitted. In particular, fitting an AI2 module to an AI4 terminal unit, or vice-versa, causes unexpected behaviour which may damage the process being controlled.

## 2.2.4 Module Removal

1. Pull the module retaining lever forwards into the unlocked position as shown in [Figure 6](#).
2. Disengage the module from the backplane connector and lift the module out of the base unit.

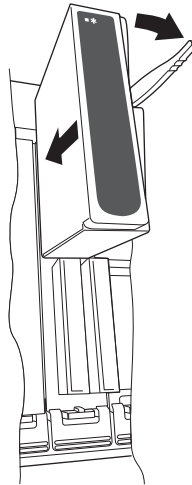

Figure 6: I/O Module installation

## 2.2.5 Module identification

The inside of the cover contains locations ('slots') for labels which can be used to identify the module fitted 'above' each slot.

A document template is supplied on DVD-ROM which allows the user to print onto a precut adhesive sheet (GA030486, supplied with the instrument). Once printed, the relevant labels can be peeled-off the backing sheet and attached to the relevant slots.

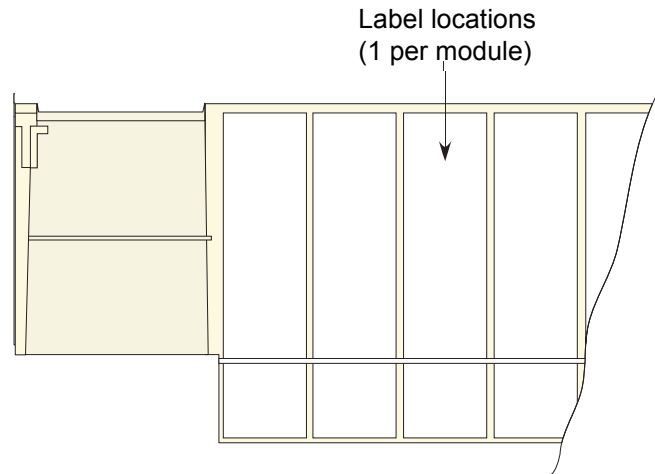

Figure 7: Inside cover

## 2.3 ELECTRICAL INSTALLATION

### 2.3.1 Controller module terminal unit

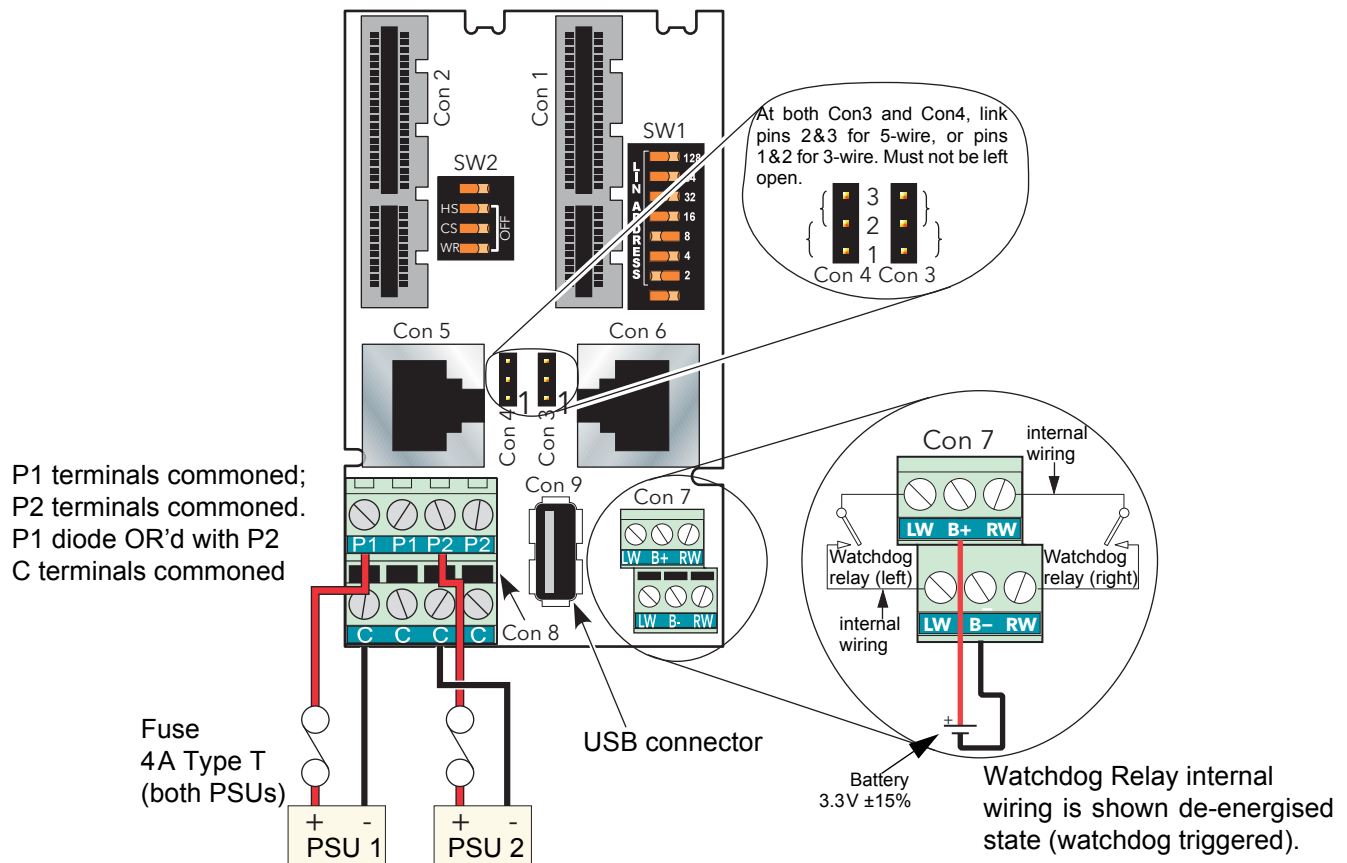

Figure 8: Controller module terminal unit wiring; watchdog relay terminals

#### Supply Wiring

Figure 8 shows the control module terminal unit with wiring details for the supply and for the battery.

The instrument supply voltage is 24Vdc  $\pm 20\%$ .

Typical power requirement is 150mA (3.6W) for the controller module, plus 0.5A (12W) for a four-module unit, 1 amp (24W) for an eight-module unit or 2 amps (48W) for a 16-module unit.



**Caution:** Do not allow the supply line to rise above 30 volts with respect to safety earth.



**Note:** should the supply voltage fall below 19.2 V during startup, the instrument will not start successfully and will attempt repeatedly to restart.

#### Fuses

The positive supply line must incorporate a fuse. A suitable type is a 4 amp Type T.

### Wire Sizes

Supply wiring: 0.25mm<sup>2</sup> to 2.5mm<sup>2</sup> (20 AWG to 14 AWG)



Note: The above diameters relate to the total cross sectional area of the conductor(s) inserted into the terminal.

### Terminal Details

Recommended screwdriver type for supply power connector: 3mm flat blade.

Maximum tightening torque: 0.6Nm.

Maximum current carrying capability: 5A per pin.



**Caution:** The maximum current carrying capacity should be considered when 'daisy chaining'.

### Safety Earth

[Figure 2](#) and associated text, above, gives safety earth details.



## Communications Connector

A pair of parallel-wired RJ45 connectors are used for EIA485 serial communications. [Figure 9](#) and [Table 3](#) give the pinout.

Pin	5-wire Master	5-wire Slave	3-wire Master/ Slave
1	RxB	TxB	B
2	RxA	TxA	A
3	Common	Common	Common
4	Not Connected	Not Connected	Not Connected
5	Not Connected	Not Connected	Not Connected
6	Common	Common	Common
7	TxB	RxB	Not Connected
8	TxA	RxA	Not Connected

Table 3: Controller module comms pinout (EIA485)

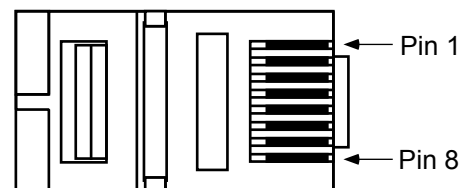

Figure 9: RJ45 plug (view on underside)



**Warning:** If the screen is earthed at both ends, it must be ensured that the earth potentials at the ends of the cable are equal. If such is not the case, very large currents can flow through the screen, causing the cable to become hot enough to harm personnel who come into contact with it, and/or to cause fire.



**Note:** The screen of the cable is connected to earth via the RJ45 connectors. Best RFI performance is achieved if the screen is also earthed at its other end, but see the Warning below

## USB Connector

A single Type-A USB connector, for USB2.0 host communications, is located on the controller module terminal unit as shown in [Figure 8](#).

The connector is intended for use with USB memory sticks, and can supply up to 500mA. Any attempt to draw more than 500mA will cause the current limiting circuitry to shut the USB power down.

The controller module contains a USB fuse which prevents the entire supply power system from being affected in the unlikely event of a catastrophic failure in the USB electronics. The fuse is not user replaceable, so if it fails, the module must be returned to the supplier for service.

CODESYS applications can access the USB port via the path `'/usb0'`.

### 2.3.2 Hardware Watchdog & Watchdog Relay

The Controller module incorporates a hardware 'watchdog' function which will trigger if system health checks fail. If the hardware watchdog triggers then:

- All I/O channels on the E+PLC400's I/O modules are forced into their power off state.
- The Controller module's processor is forced into the reset state—any running application is terminated.
- The watchdog relay is de-energised (contacts open)—see below.
- The red Fault Indicator LED on the Controller module (see [section 2.3.3](#)) will flash for 10 seconds.

#### Recovery from a hardware watchdog trigger

- Default behaviour: Automatic restart

With standard factory default settings, if the hardware watchdog triggers, the red Fault Indicator LED will begin to flash, and the E+PLC400 will automatically attempt to restart within 10 seconds.

If the restart is successful, the red Fault Indicator LED will go out. If the E+PLC400 was running a boot application, then this should restart too.

- Manual restart

It is possible to change the default restart behaviour following a hardware watchdog trigger. To change the restart behaviour, set the 'watchdog retry' switch on the Controller module terminal unit to the 'OFF'. (The switch is labelled **WR** in the **SW2** block—see [Figure 8](#)).

With the WR switch in the OFF position, the E+PLC400 will not automatically restart following a hardware watchdog trigger. The red Fault Indicator LED will remain on continuously.

In this circumstance, you can manually restart the E+PLC400 by pressing the recessed Watchdog button on the Controller module (see [section 2.3.3](#)). If the manual restart is successful, the red Fault Indicator LED will go out.

#### Watchdog Relay

The hardware watchdog controls a relay on the Controller module, which is accessible via the **LW** and **RW** terminals on **Con7** (see [Figure 8](#)). Typically, you can use these to connect additional hardware to the E+PLC400 that will provide appropriate interlock behaviour in the event of the watchdog triggering. The contact ratings (resistive loads) for the watchdog relays are 30Vac / 60Vdc at 0.5A.



Note: If the watchdog relay outputs are routed outside the cabinet in which the E+PLC400 is mounted, a clip-on ferrite should be fitted round all watchdog leads, and positioned as closely as possible to the instrument. A suitable ferrite is available from Eurotherm, part number CO025698.

The watchdog relay behaves as set out in [Table 4](#).

Condition	Resulting Watchdog Relay state
An application is running	Relay energised (contacts closed)
If any of the following apply: —The E+PLC400 is powered off. —During initial power up (until system health checks are completed). —An application is terminated. —The processor enters the reset state. —A signal to open the relay is received from the application (for more details, refer to the E+PLC400 Online Help—see <a href="#">section 3.1</a> )	Relay de-energised (contacts open)

Table 4: Switching conditions for the Watchdog Relay

### 2.3.3 Controller module status indicators

Figure 10 shows the controller module front panel, with status LEDs. Details are listed in Table 5.

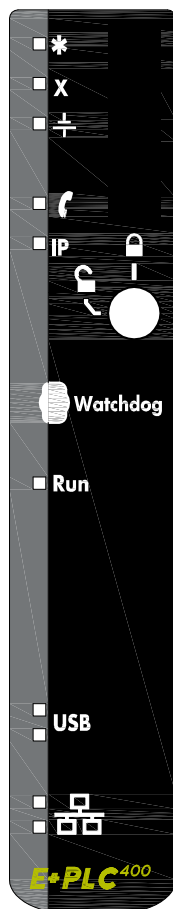

Figure 10: Controller module LEDs

Icon	Name	LED Colour	Meaning
*	Power status	green	On: Main power input valid Off: Main power input failed
X	Fault indicator	red	On: Module missing or faulty Flashing: Hardware watchdog has triggered (see section 2.3.2). Off: No hardware faults detected
+	Battery status	green	On: Battery OK Flashing: battery failed or not fitted
☎	Serial Comms status	green	On: serial communications are being transmitted Off: no active serial communications
IP	Ethernet IP status	green	On: E+PLC400 online with at least one CIP connection Flashing: E+PLC400 online but with no CIP connections Off: E+PLC400 is initialising communications or a connection has timed out
Watchdog	Watch-dog reset button	none	Recessed button. If the red Fault Indicator LED is On solidly, pressing this button will initiate a system restart (see section 2.3.2).
Run	PLC program run status	green	Off: E+PLC400 firmware has not yet booted up. (Booting should normally complete within 30 seconds). Flashing: E+PLC400 has booted up and is ready to run programs. On: A program is currently running (initiated from the <b>Online</b> menu in the CODESYS software)
USB	USB software	green	On: USB device powered. Flashing: USB device being accessed. The USB device must not be removed. Off: USB device not powered and may be removed.
	USB hardware	yellow	On: an attempt is being made to draw too much current (> 500 mA) from the USB socket. USB activity suspended. Off: No hardware failure reported.
Ethernet speed/activity	Ethernet speed	green	On: 100 MB Off: 10 MB
	Ethernet activity	yellow	On: Connected to a live Ethernet network Flickering; Network traffic detected Off: Ethernet connection invalid

Table 5: Controller module LEDs

### 2.3.4 Two-channel analogue input (AI2)

This module can be ordered with terminal unit variants to measure thermocouple inputs (AI2-TC), voltage or resistance thermometer inputs (AI2-DC), or current (AI2-MA). Figure 11 gives pinout details.

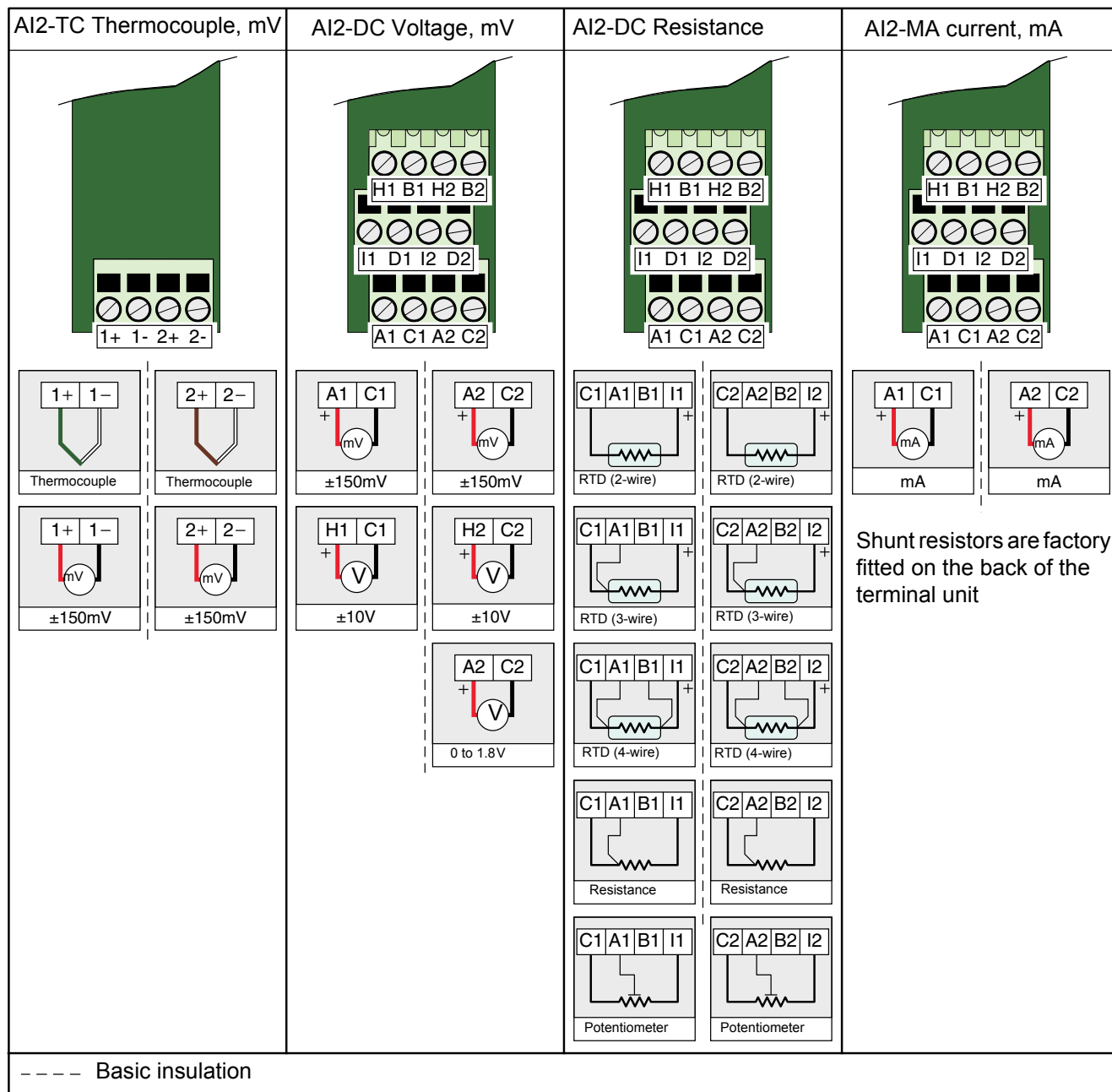

Figure 11: AI2 module pinout



Note: The module terminals accept wire sizes from 0.20 to 2.5mm<sup>2</sup> (14 to 24AWG). The screws should be tightened to 0.4Nm (5.3lbin) using a 3.5mm flat blade screwdriver.

## Status Indicators

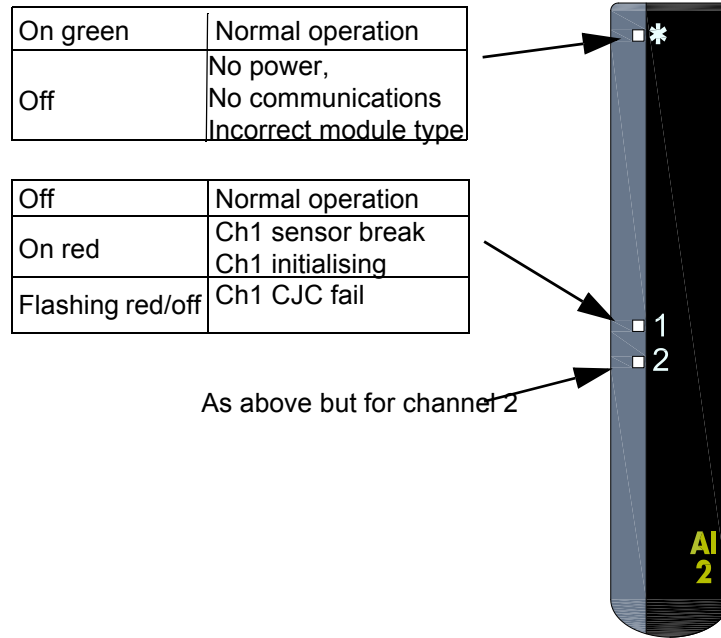

Figure 12: AI2 Status indicators



Note: Flashing = 0.5s on, 0.5s off

### 2.3.5 Three-channel analogue input (AI3)

This module provides three isolated mA input channels. An isolated 24 V (nominal) supply is available across the 'P' and 'C' terminals for powering the current loop. If the current loop is self powered, the 'C' and 'I' terminals should be used. Figure 13 shows the pinout.

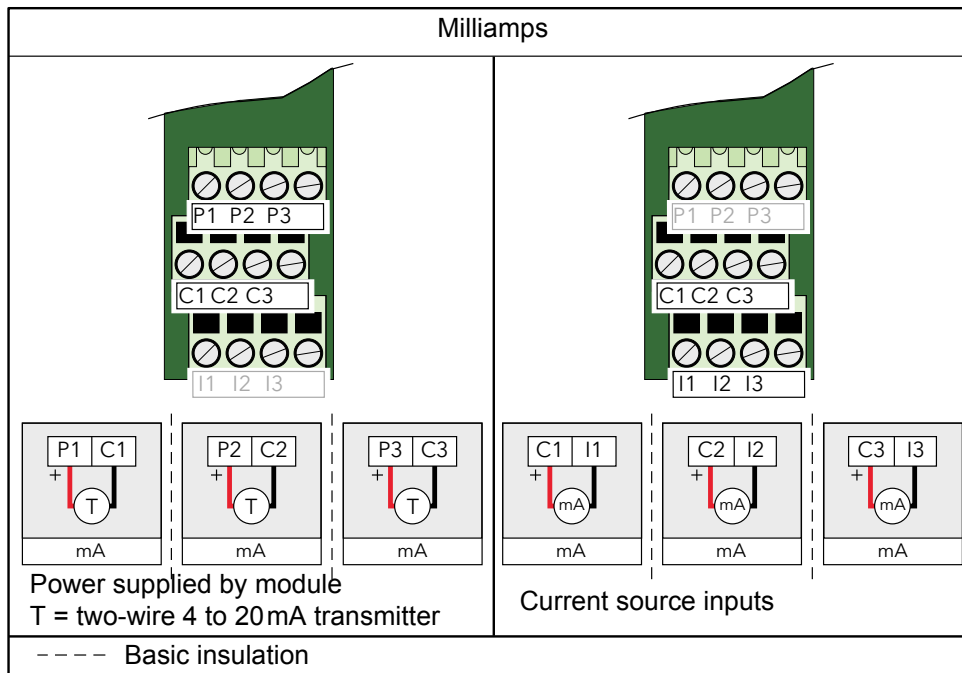

Figure 13: AI3 module pinout

#### Status Indicators

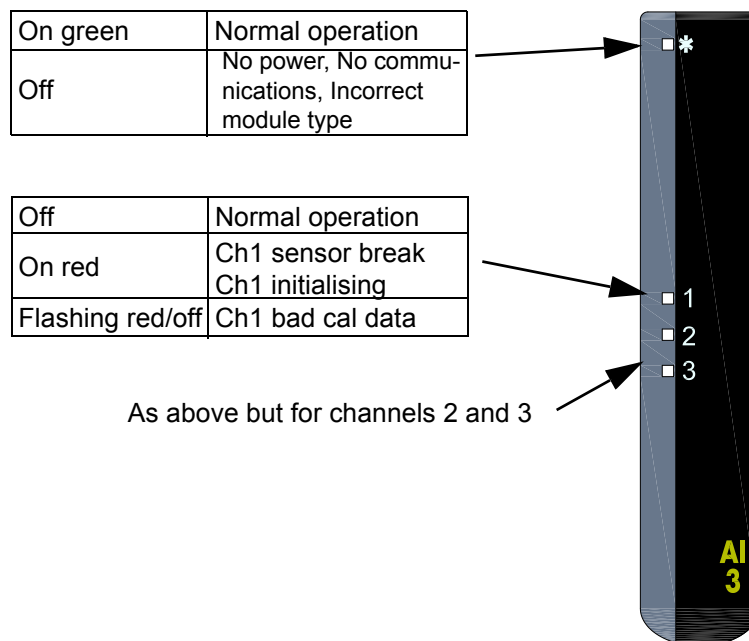

Figure 14: AI3 Status indicators



Note: The module terminals accept wire sizes from 0.20 to 2.5mm<sup>2</sup> (14 to 24AWG). The screws should be tightened to 0.4Nm (5.3lbin) using a 3.5mm flat blade screwdriver.

Note: Flashing = 0.5s on, 0.5s off

## HART Compatibility

For each channel a  $195\Omega$  resistor is fitted in the input circuitry to the amplifier. Normally, these resistors are by-passed by printed circuit links on the underside of the terminal unit. In order to make the module HART compatible, these links can be cut, placing the resistors in series with the amplifier inputs.

Figure 15 shows the module equivalent circuit, and figure 16 shows the location of the links on the underside of the terminal unit.

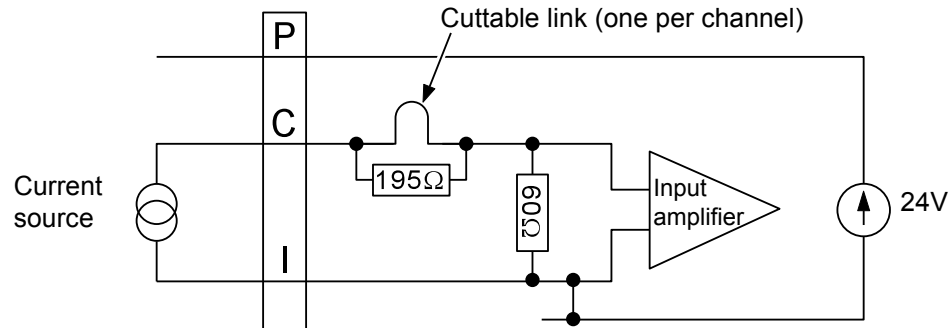

Figure 15: AI3 module equivalent circuit

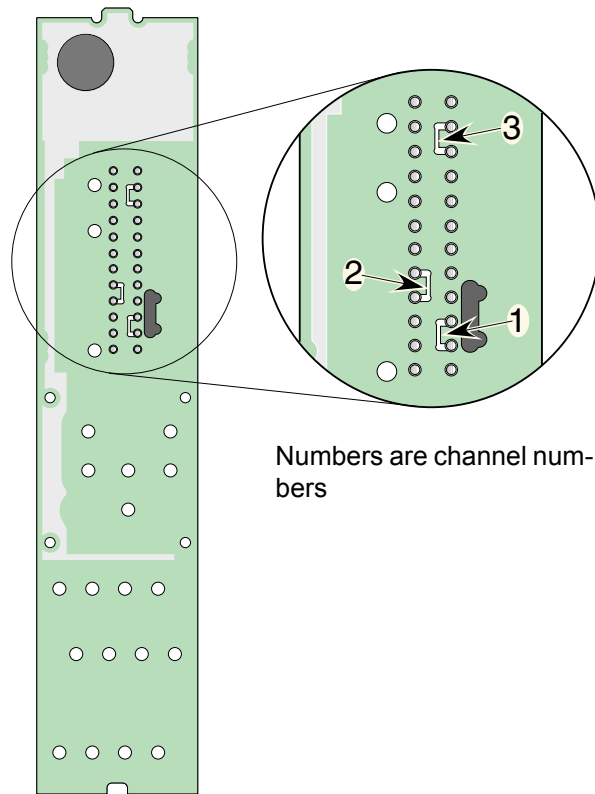

Figure 16: Link locations on underside of terminal unit

### 2.3.6 Four-channel analogue input (AI4)

This module is ordered with a particular terminal unit variant, to measure thermocouple, voltage or current inputs. Figure 17 gives pinout details.

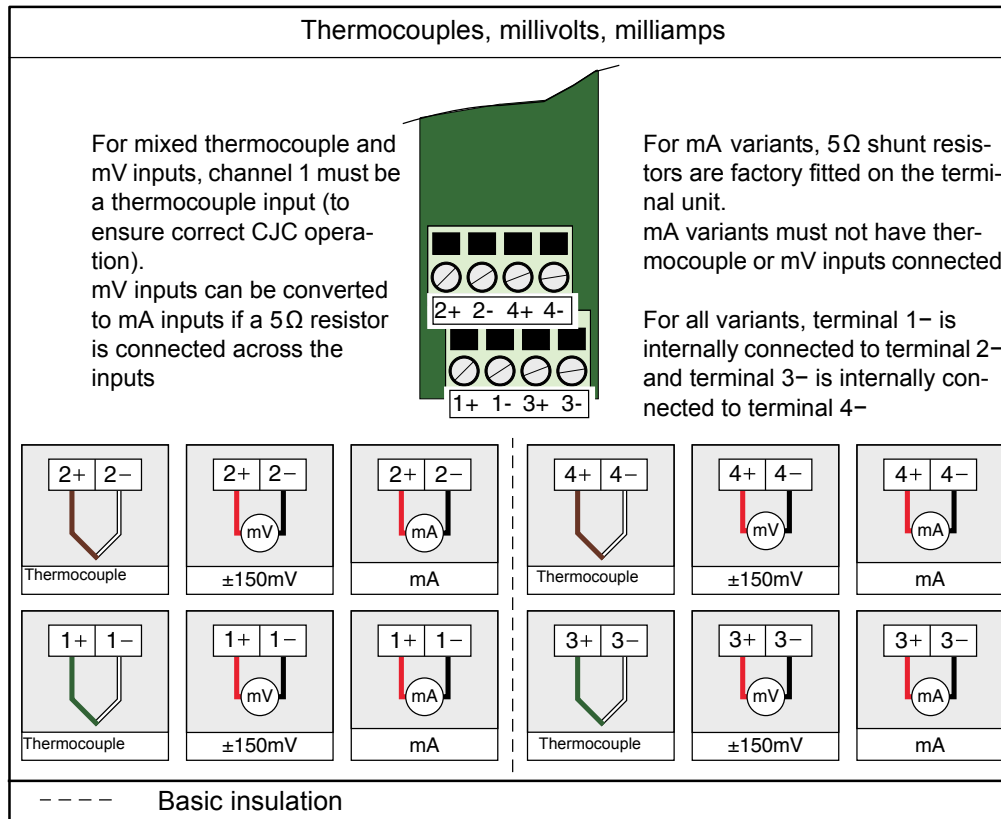

Figure 17: AI4 module pinout



Note: The module terminals accept wire sizes from 0.20 to 2.5mm<sup>2</sup> (14 to 24AWG).  
The screws should be tightened to 0.4Nm (5.3lbin) using a 3.5mm flat blade screwdriver.



## Status Indicators

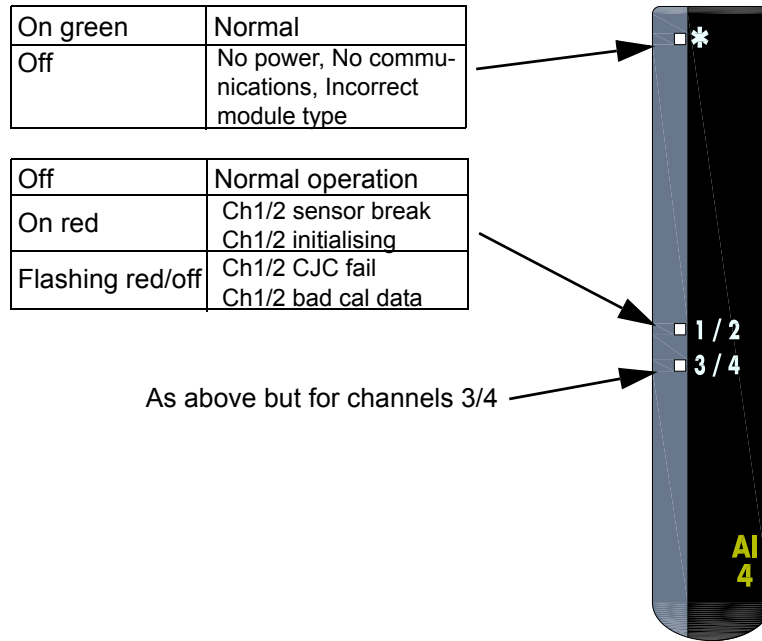

Figure 18: AI4 status indicators



Note: Flashing = 0.5s on, 0.5s off

### 2.3.7 High density analogue input (AI8)

This module can be ordered as one of four variants (each of which has a different terminal unit):

- **AI8-RT**—four channels of isolated platinum resistance thermometer (RTD) inputs, standard polling rate. See [Figure 19](#) for terminal pin-out details.

For the following three variants, the channels are isolated in pairs.

- **AI8-MA** or **AI8-FMA**—eight isolated channels of current (mA) inputs, standard polling rate and fast polling rate, respectively. See [Figure 20](#) for terminal pin-out details.
- **AI8-TC**—eight channels of thermocouple inputs (with cold junction compensation) or voltage (mV) inputs, standard polling rate. See [Figure 21](#) for terminal pin-out details.

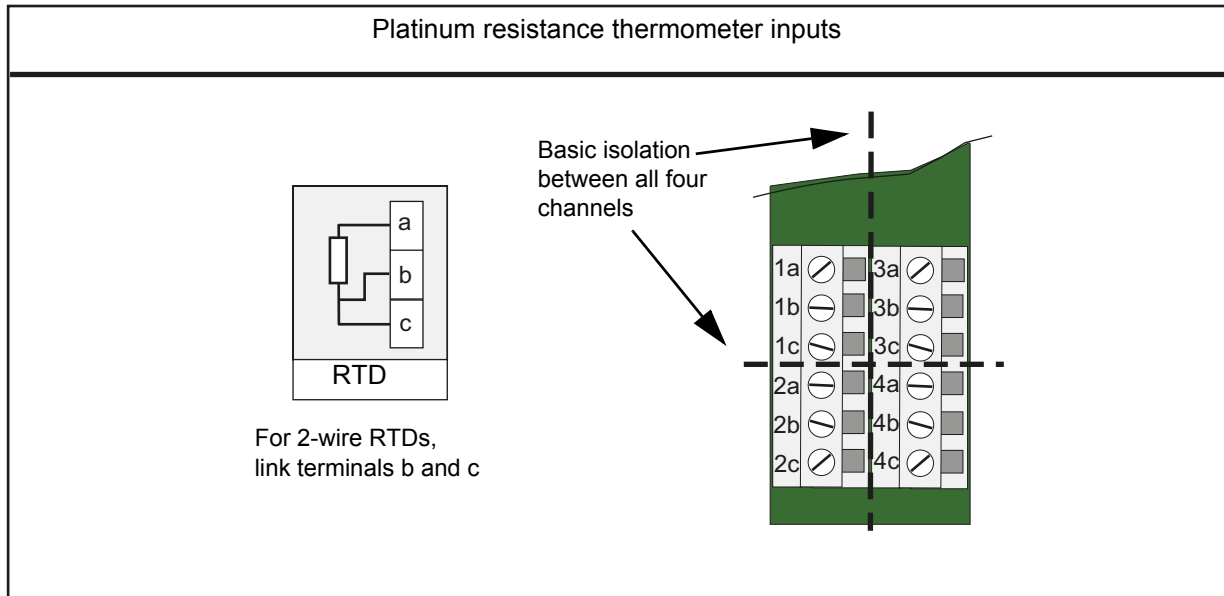

Figure 19: AI8-RT terminal unit

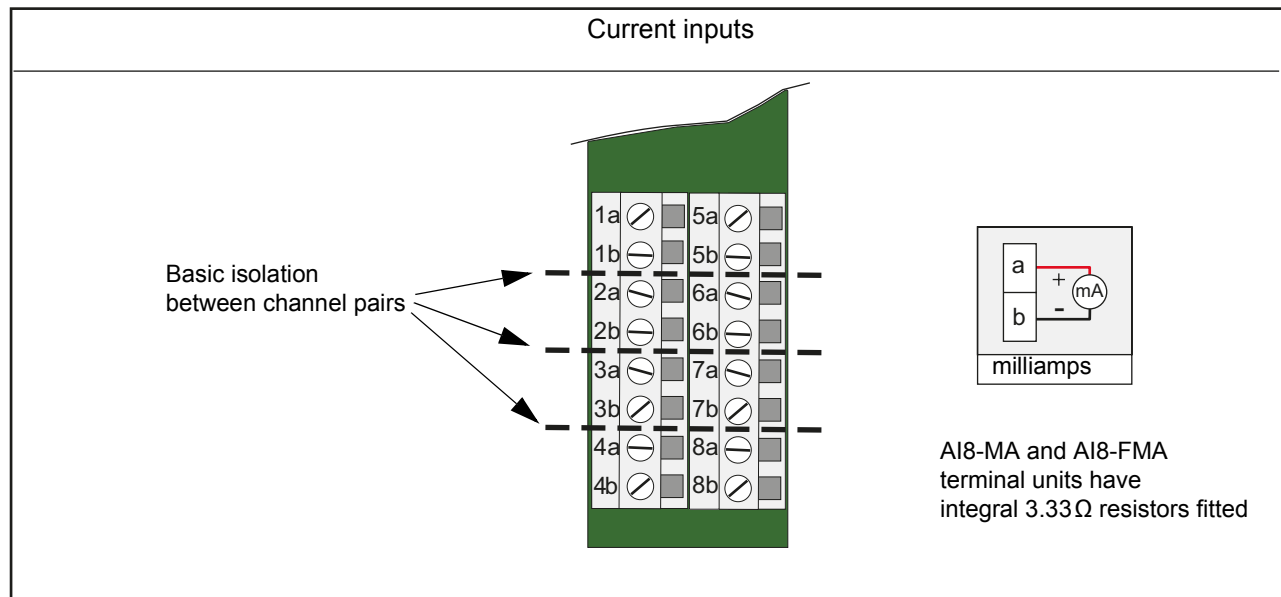

Figure 20: AI8-MA and AI8-FMA terminal units

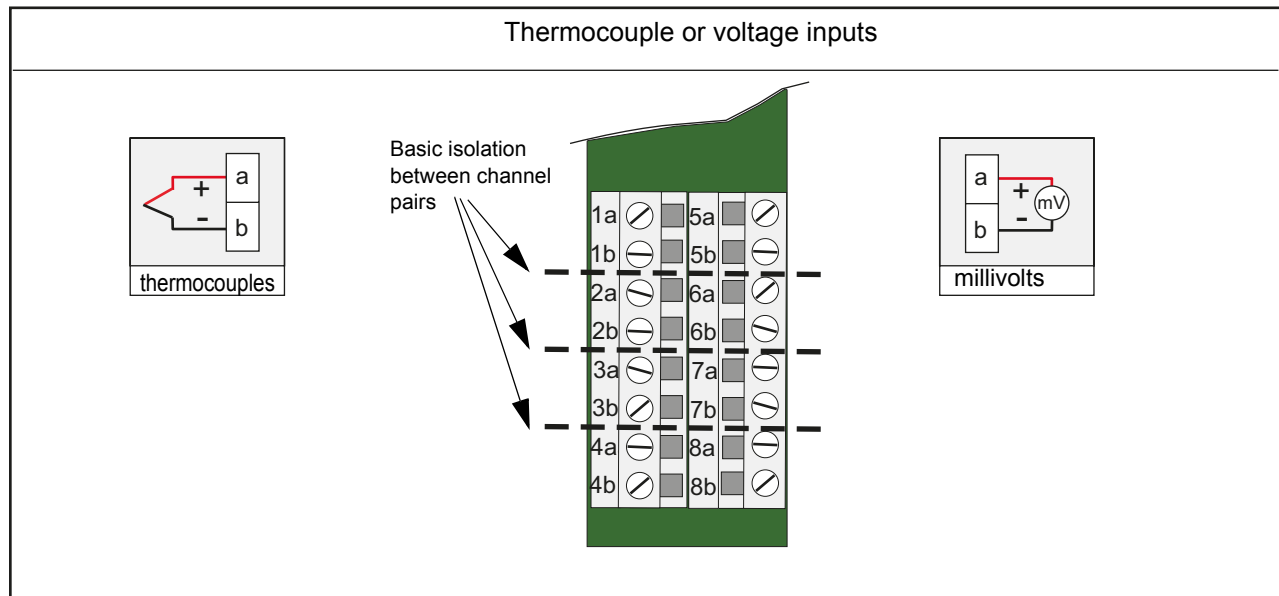

Figure 21: AI8-TC terminal units



**Caution:** For connections to the AI8-TC terminal unit, if thermocouple wiring needs to be extended, use the correct compensating cable and ensure that polarity is followed throughout.



**Caution:** When using the AI8-TC variant, if sensor break is enabled on a channel (i.e. in the CODESYS software, in the module's **Module Configuration** tab, the **Break Response** parameter for a channel is set to **Detect Only**), do not connect more than one input to a single source (thermocouple or mV) since this may compromise the measurement and sensor break action. Also, it is not recommended to connect additional instruments to a single input source.

### Status indicators

As shown in the [Figure 22](#) below, the AI8 module's status is shown by a single green LED, whilst the status of each individual channel is shown by a red LED.

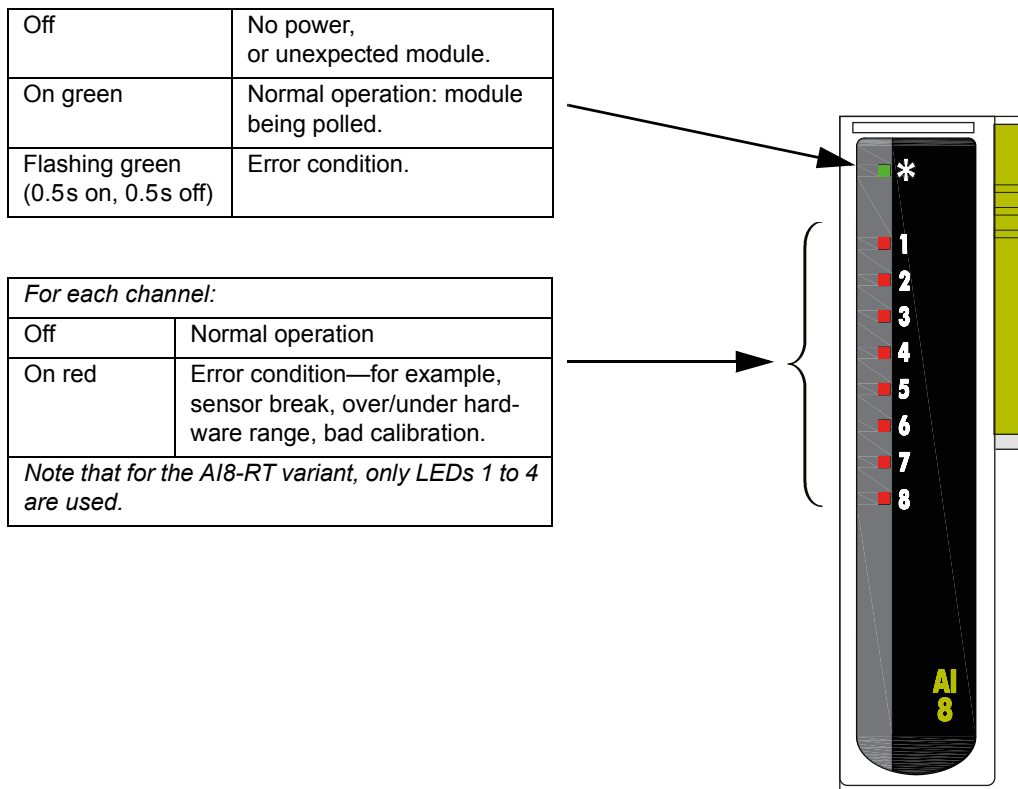

Figure 22: AI8 module status

### 2.3.8 Two-channel analogue output (AO2)

This module provides two isolated output channels which can be configured independently (in software) as voltage or current source outputs. The specified voltage output range (0 to 10V) can be expanded slightly (−0.3V to +10.3V) by limiting the load to a minimum value of 1500Ω. Figure 23 gives the module pinout.

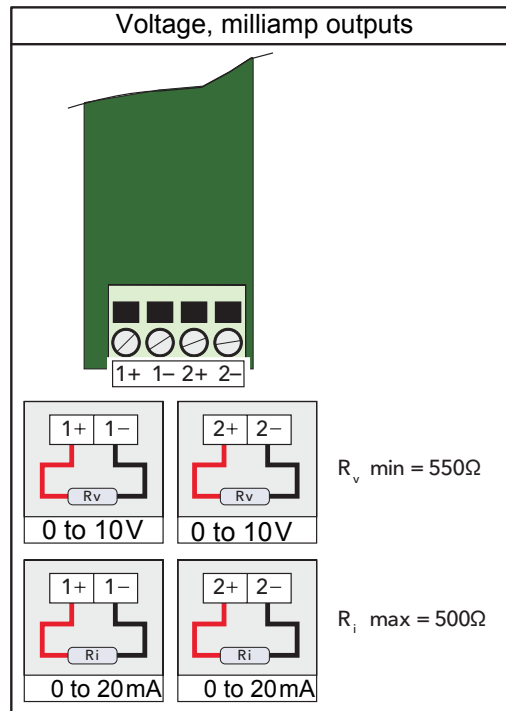

Figure 23: AO2 module pinout



Note: The module terminals accept wire sizes from 0.20 to 2.5mm<sup>2</sup> (14 to 24AWG). The screws should be tightened to 0.4Nm (5.3lbin) using a 3.5mm flat blade screwdriver.

## Status Indicators

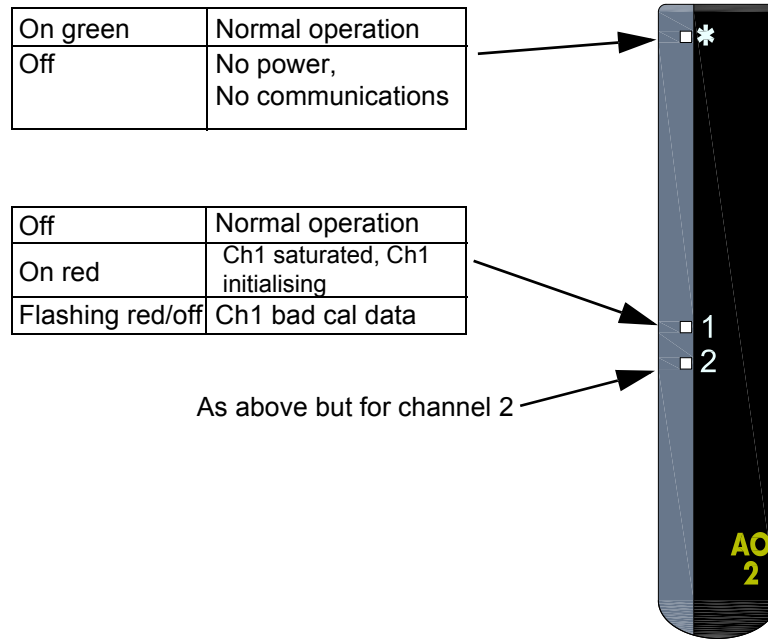

Figure 24: AO2 module status indicators



Note: Flashing = 0.5s on, 0.5s off

### 2.3.9 Six-channel digital input module (DI6)

This module provides six isolated ac logic input circuits. The module is available in two versions, one suitable for nominal 230V RMS, the other for nominal 115V RMS. It is not possible for the user to convert one DI6 version to the other.



**Caution:** Using the 115V version with 230V inputs causes power consumption higher than specified, which can lead to overheating and eventual failure.  
Using the 230V version with 115V inputs may cause intermittent switching as 115V lies outside both the off and the on switching voltage ranges

#### Status Indicators

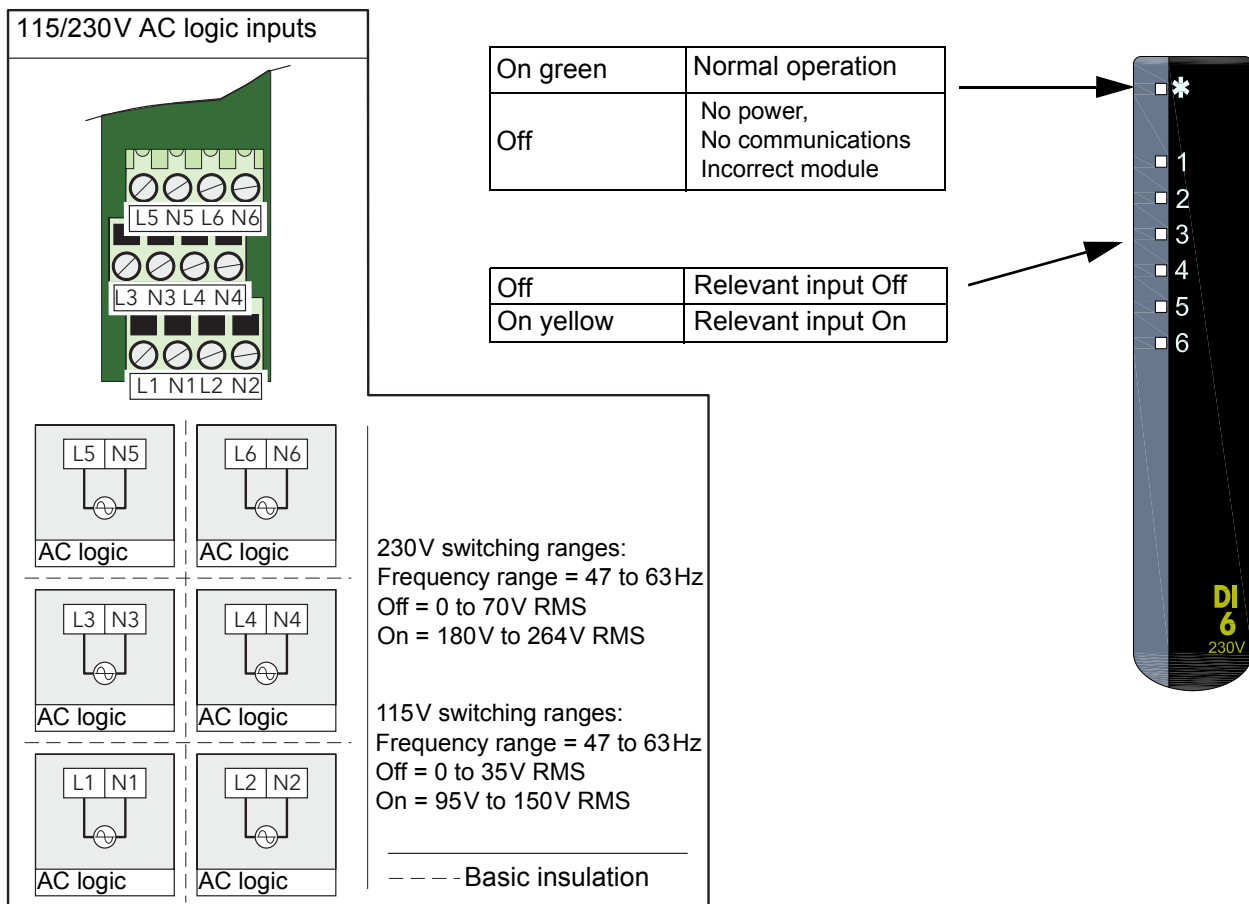

Figure 25: DI6 module pinout & status indicators (230V version shown; 115V version similar)

### 2.3.10 16-Channel digital output module (DO16)

This module provides 16 digital outputs of up to 700mA each. Two sets of power supply inputs are included, with the 'C' terminals being internally connected. The 'P' terminals are not internally connected.



**Caution:** If the module is inserted into a powered base unit, the outputs might turn on fleetingly (up to 8ms). The module should not be inserted into a powered base unit where such fleeting outputs could be damaging to the process being controlled, unless the wiring has first been disconnected.



**Note:** Any 'plant-side' power supply connected to a DO16 module must be capable of supplying an inrush current of 30A for 100µs

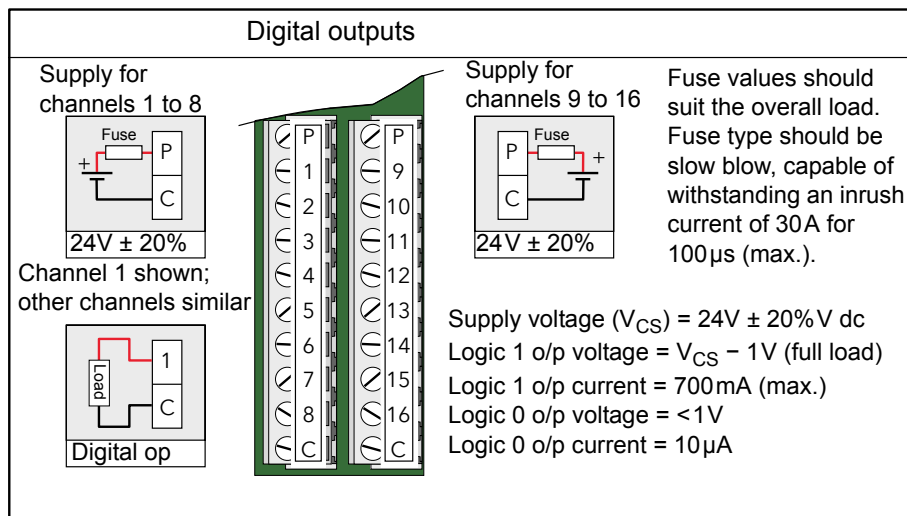

Figure 26: DO16 module pinout

In the CODESYS software, you can configure DO16 channels to operate as the following types: On/Off, Time Proportioned or Valve Positioner. Selecting the Valve Positioner type ties together a pair of adjacent outputs, with the positive part of the signal handled by the odd-numbered output, and the negative part of the signal handled by the even-numbered output.



Status indicators

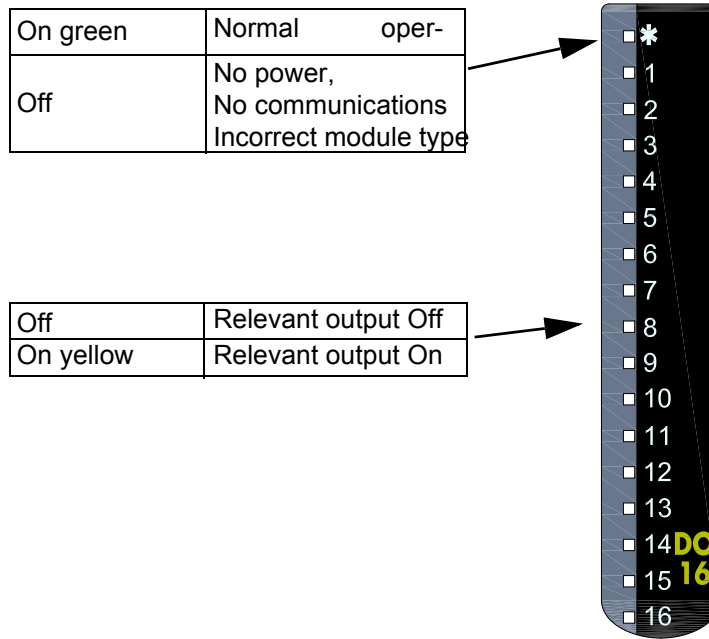

Figure 27: DO16 module status LEDs

### 2.3.11 16-Channel digital input module (DI16)

This module provides 16 digital inputs which support either logic inputs or contact closure inputs. Both input types may be freely mixed on each DI16 module.

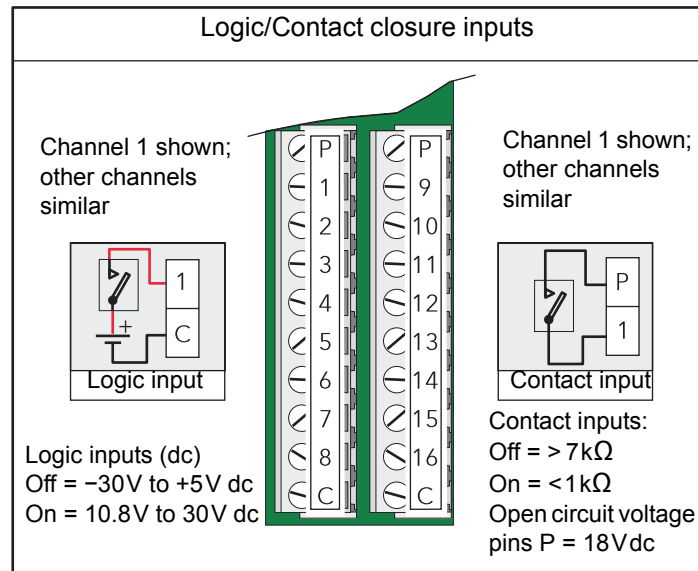

Figure 28: DI16 module pinout



Note: The 'P' terminals are internally connected together and the 'C' terminals are internally connected together.

The module terminals accept wire sizes from 0.20 to 2.5 mm<sup>2</sup> (14 to 24 AWG). The screws should be tightened to 0.4 Nm (5.3 lbin) using a 3.5 mm flat blade screwdriver.

#### Status Indicators

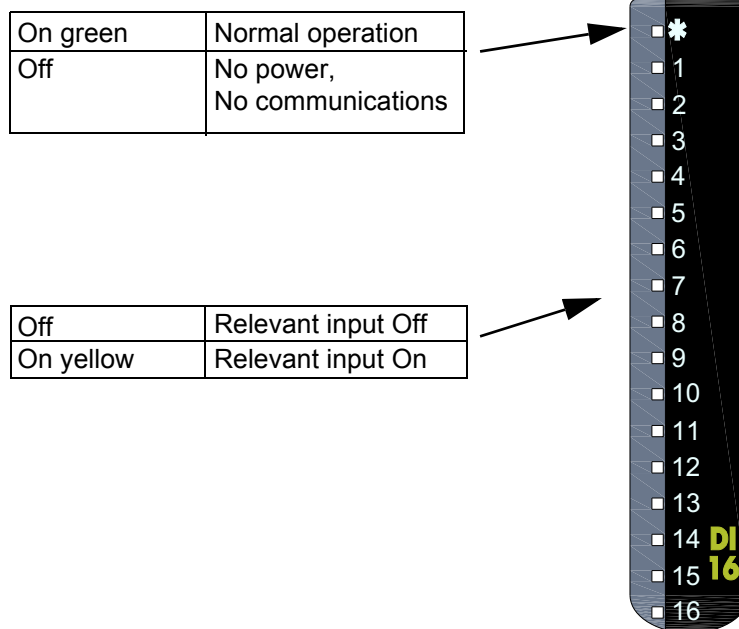

Figure 29: DI16 module status indicators

### 2.3.12 Eight output relay module (RLY8)

This module provides eight relay outputs with common/normally open contacts. No snubber circuitry is built into this module so it is the responsibility of the user to incorporate such circuit elements as are necessary to protect the relay contacts from undue wear, and to maintain CE compliance for the system.

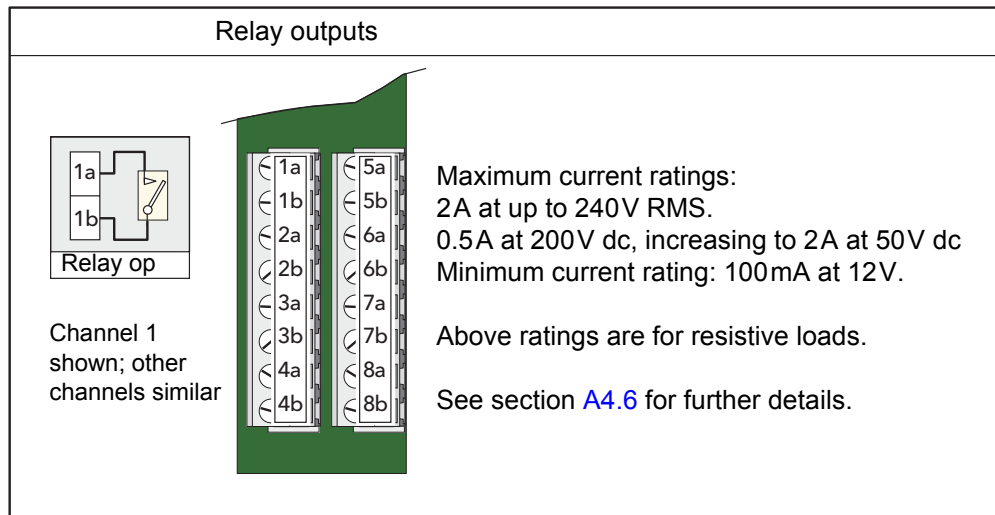

Figure 30: RLY8 module pinout



Note: The module terminals accept wire sizes from 0.20 to 2.5mm<sup>2</sup> (14 to 24AWG). The screws should be tightened to 0.4Nm (5.3lbin) using a 3.5mm flat blade screw-driver.

In the CODESYS software, you can configure RLY8 relay channels to operate as the following types: On/Off, Time Proportioned or Valve Positioner. Selecting the Valve Positioner type ties together a pair of adjacent relays, with the positive part of the output signal handled by the odd-numbered relay, and the negative part of the output signal handled by the even-numbered relay.

#### Status Indicators

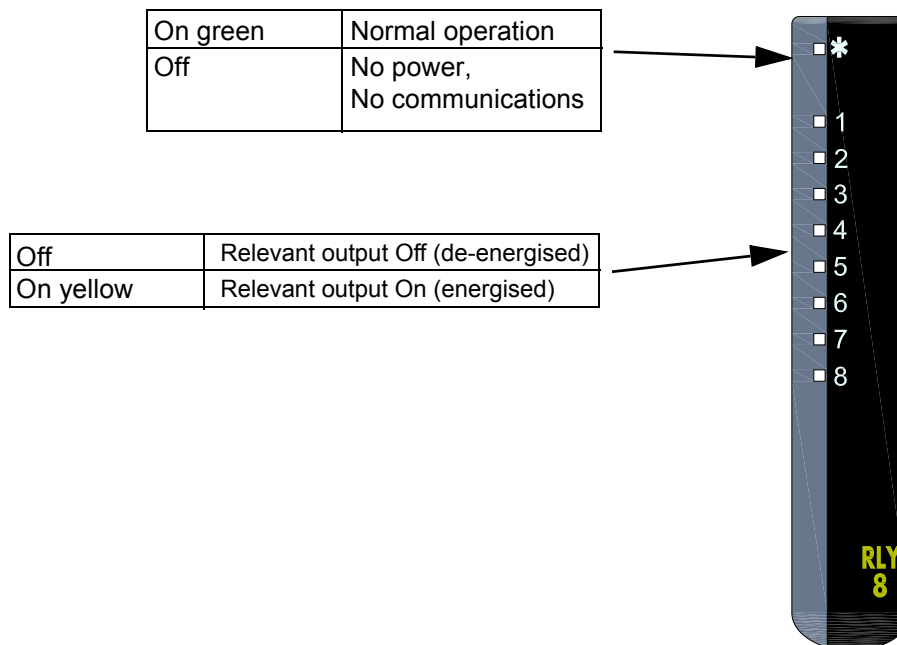

Figure 31: RLY8 status indicators

### 2.3.13 Zirconia input module (ZI)

This module consists of two input channels isolated both from each other and from the system electronics, used to measure the zirconia probe temperature (thermocouple input to channel one) and the zirconia probe output signal (channel two). The cold junction compensation for the thermocouple input is provided by a resistance temperature detector (RTD) mounted on the terminal unit.

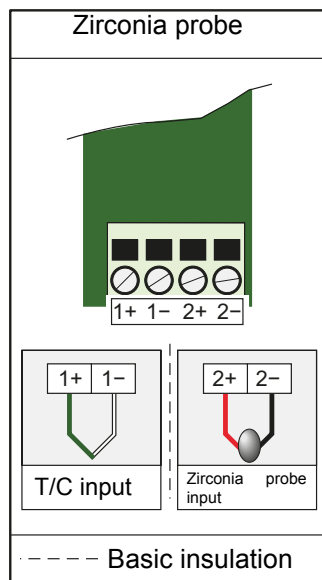

Figure 32: ZI Module pinout

#### Status indicators

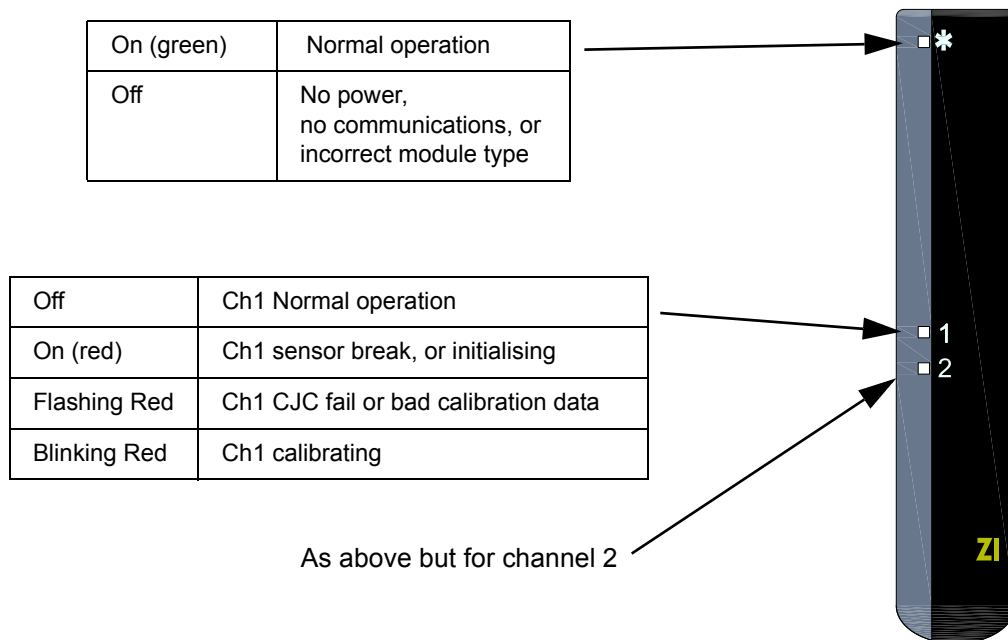

Figure 33: Zirconia module LEDs



Note: Flashing = 50ms on, 50ms off  
Blinking = 0.2s on, 1.8s off

### 3 CODESYS Software

The E+PLC400 is configured and monitored using the CODESYS Development System software, running on a Windows PC.

#### 3.1 Accessing the CODESYS Online Help.

The CODESYS software includes extensive online help.



A tutorial video on how to **Find further information and use HELP** is available on the Eurotherm web portal.  
In the CODESYS Development System, select **View > Start Page** to display the portal in the main CODESYS window.

To launch the CODESYS help, click on its **Help** menu (figure 34):

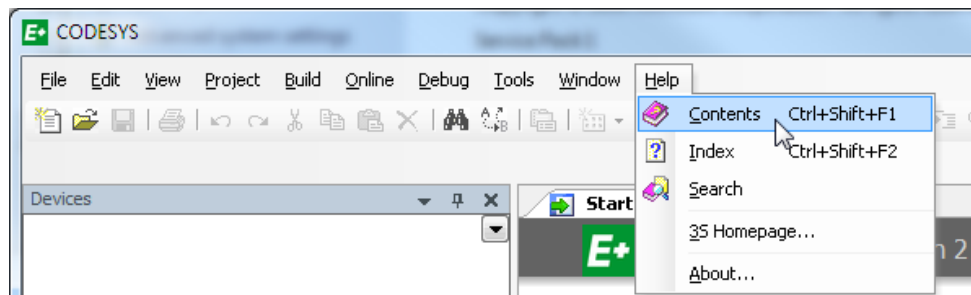

Figure 34: Launching the CODESYS online help

The **Online Help** window is displayed (figure 35)

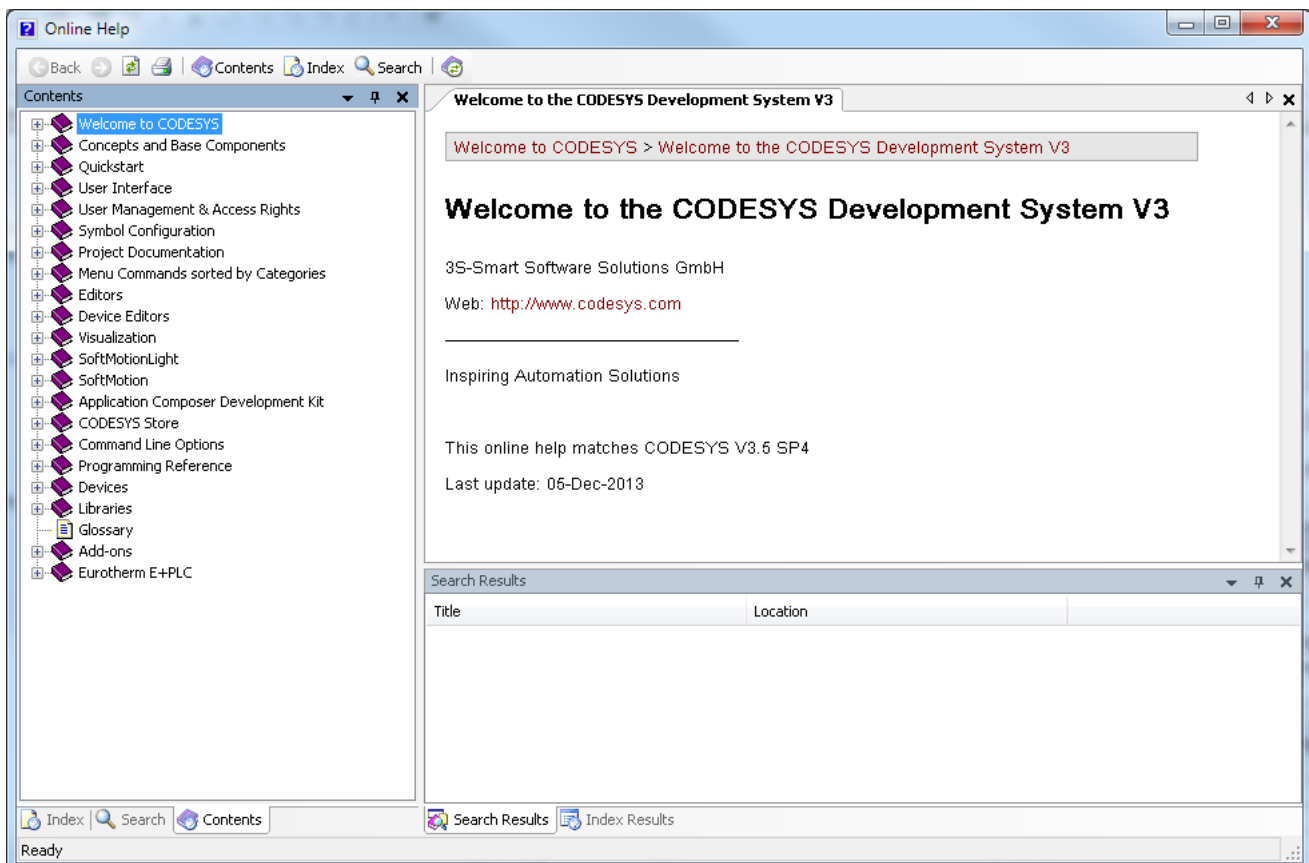

Figure 35: The CODESYS Online Help viewer

## 3.2 CODESYS Library Documentation

In addition to the CODESYS Online Help, CODESYS libraries include their own documentation, with detailed information on the POU (Program Organization Units) in the library (such as functions and function blocks). You can view this in the CODESYS editor windows themselves, for instance in the **Library Manager** (figure 36).

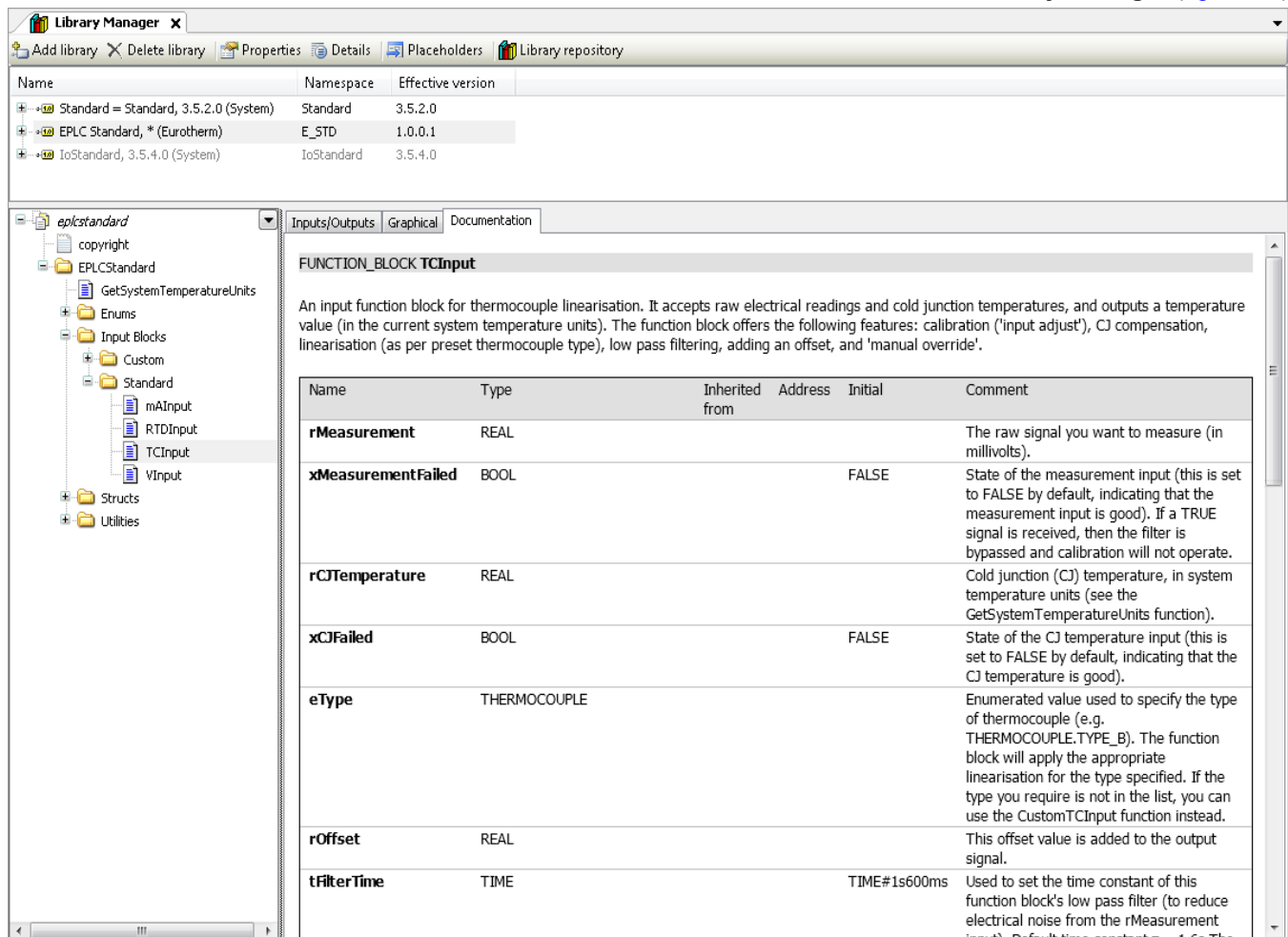

Figure 36: Viewing library documentation in the CODESYS Library Manager

A subset of the same information is also displayed in a tooltip when you hover over POU with the mouse. To display information on a POU in the Online Help window, select the POU and press **F1**.

### 3.3 'How to' tutorial videos and example projects

Eurotherm also provide a range of "How to" tutorial videos and example projects for the E+PLC400. These are available on a Eurotherm web portal. To launch the portal from within the CODESYS Development System, select **View > Start Page** from the menus (figure 37).



Note: to access the online tutorials, the PC running your CODESYS software must have Internet access

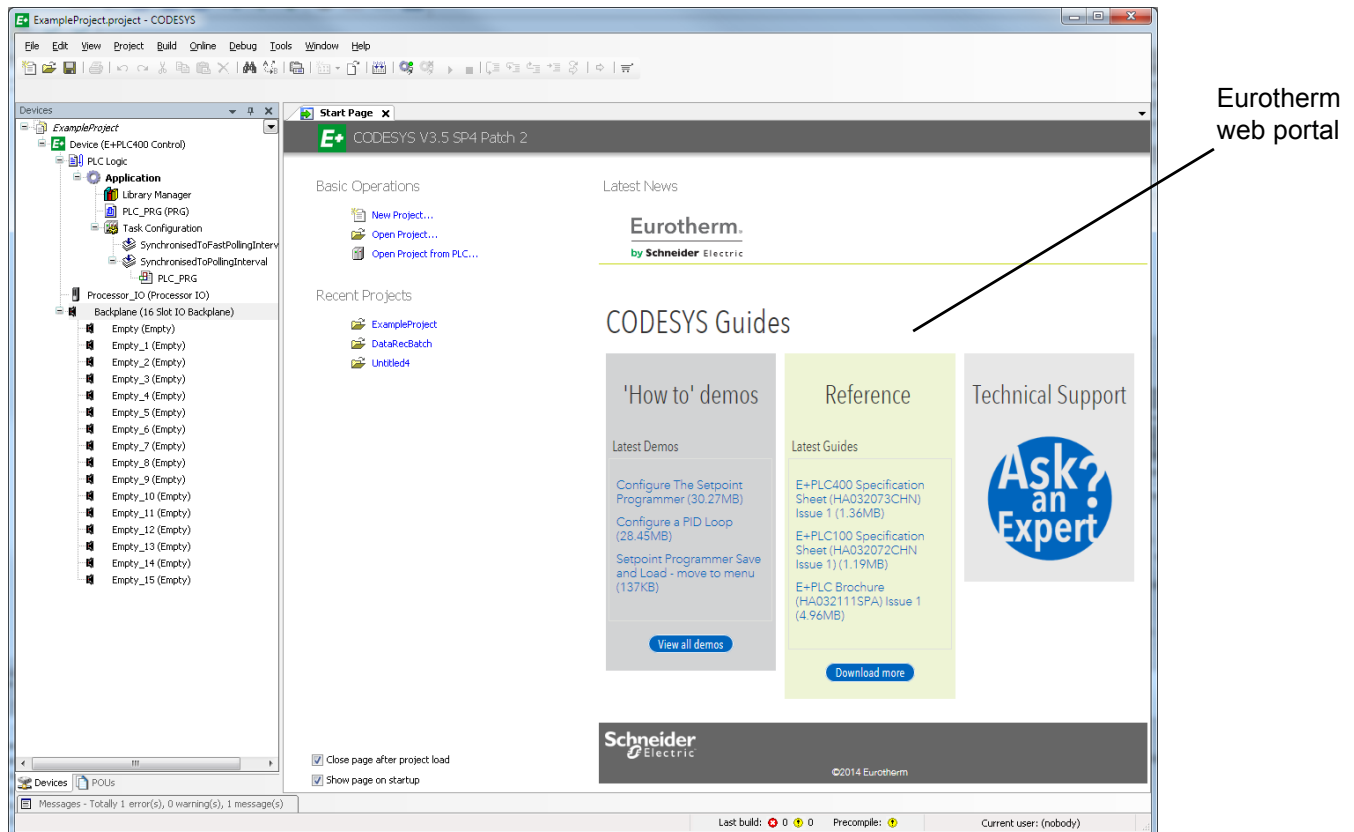

Figure 37: Accessing the Eurotherm web portal from within the CODESYS Development System

This page is intentionally blank



## Appendix A: SPECIFICATION

### A1 INSTALLATION CATEGORY AND POLLUTION DEGREE

This product has been designed to conform to BS EN61010-1 installation category II and pollution degree 2. These are defined as follows:

#### INSTALLATION CATEGORY II

The rated impulse voltage for equipment on nominal 230V ac mains is 2500V.

#### POLLUTION DEGREE 2

Normally, only non-conductive pollution occurs. Occasionally, however, a temporary conductivity caused by condensation shall be expected.

### A2 GENERAL SPECIFICATION

#### A2.1 Physical

<b>Backplane dimensions:</b>	0 module:	61 mm wide × 180 mm high × 132 mm deep (2.41 in × 7.1 in × 5.2 in)
	4 module:	172.4 mm wide × 180 mm high × 132 mm deep (6.79 in × 7.1 in × 5.2 in)
	8 module:	274 mm wide × 180 mm high × 132 mm deep (10.8 in × 7.1 in × 5.2 in)
	16 module:	477 mm wide × 180 mm high × 132 mm deep (18.8 in × 7.1 in × 5.2 in)

<b>Backplane fixing centres:</b>	0 module:	26 mm (1.023 in)
	4 module:	127.4 mm (5.02 in)
	8 module:	127.4 mm (5.02 in)
	16 module:	432.2 mm (17.016 in)

<b>Weight:</b>	0 module:	0.7 kg (1.54 lb). Including controller module
	4 module:	No modules = 0.7 kg (1.54 lb). Including controller and 4 × I/O modules = 1.65 kg (3.64 lb) max
	8 module:	No modules = 0.98 kg (2.16 lb). Including controller and 8 × I/O modules = 3.1 kg (6.83 lb) max.
	16 module:	No modules = 1.6 kg (3.53 lb). Including controller and 16 × I/O modules = 5.24 kg (11.55 lb) max.

See [figure 1](#) and [figure 2](#) for dimensional details.

#### A2.2 Electrical

<b>Safety earth connections:</b>	Earth terminal strip at lower front flange of base unit.
<b>Supply voltage:</b>	24 V dc (±20%)
<b>Supply power (max.):</b>	82 watts (16 module base)
<b>Surge current (max.):</b>	8 amps
<b>Back-up supply:</b>	BR2450 3V lithium coin cell fitted inside backplane side panel ( <a href="#">Figure 8</a> ).



Note: If the supply voltage falls below 19.2 V dc during startup, the instrument can enter a continuous cycle of attempted re-starts.

## A2.3 Environmental

<b>Temperature:</b>	<b>Storage:</b>	-20 to +85 °C
	<b>Operation:</b>	0 to + 55 °C
<b>Humidity:</b>	<b>Storage/Operation:</b>	5 to 95% RH (dew-point 50 °C ) (See <a href="#">figure 38</a> ).
<b>Atmosphere:</b>		Non-corrosive, non-explosive.
<b>Altitude (max.):</b>		2000m
<b>Environmental protection:</b>	<b>Panel:</b>	BS EN60529:IP20
<b>RFI:</b>	<b>EMC emissions:</b>	BS EN61326-1:2006 Class A
	<b>EMC immunity:</b>	BS EN61326-1:2006 Industrial locations.
<b>Electrical Safety Specification:</b>		BS EN61010-1: 2001 (see <a href="#">section A1</a> , above); UL61010-1.
<b>Vibration:</b>		BS EN61131-2 (9 to 150Hz @ 1g; 1 octave per minute).
<b>Shock:</b>	<b>Impact withstand:</b>	BS-EN61131-2 (Corner drop test 100 mm)
	<b>Packaging:</b>	BS EN61131-2
	<b>Free fall:</b>	BS EN60068-2-32, proc. 1 (five × 1 metre drops for each of six faces).
<b>Flammability of plastic materials</b>		UL746 UL V0
<b>RoHS compliance</b>		EU; China

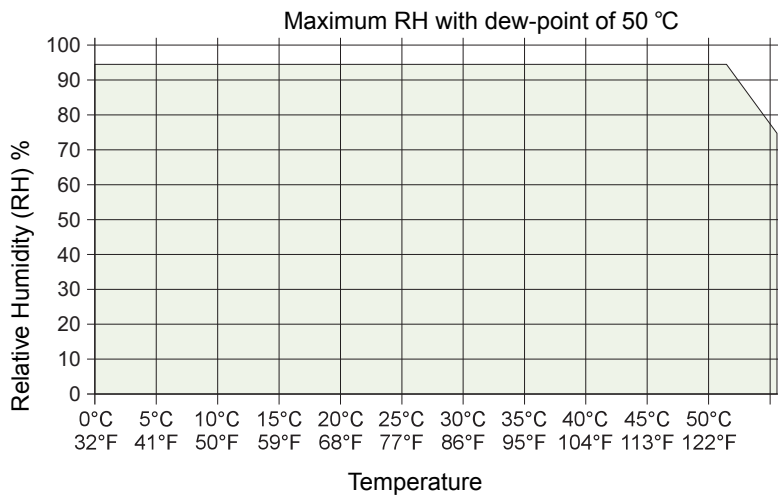

Figure 38: E+PLC400 Humidity tolerance

## A2.4 Approvals

CE; cUL (UL61010-1), file number E57766; GOST CUTR

## A2.5 Ethernet Communications

<b>Connectors:</b>	RJ45 connector located on the controller module.
<b>Network medium:</b>	Ethernet Category 5 cables.
<b>Protocols:</b>	Modbus–TCP RTU slave, FTP.
<b>Speed:</b>	100 Mbps.
<b>Network Topology:</b>	Star connection to a hub.
<b>Line length (max):</b>	100 metres, extendible by repeater.
<b>Allocation of IP address:</b>	Manual or DHCP.
<b>Isolation:</b>	50Vdc; 30Vac. (IEEE 802.3)

## A2.6 Modbus Communications

<b>Connector:</b>	Parallel pair of RJ45 connectors on the Controller module terminal unit.
<b>Network medium:</b>	EIA485, link selectable as 3-wire or 5-wire.
<b>Protocols:</b>	MODBUS RTU master and slave.
<b>Isolation:</b>	None.

## A3 CONTROLLER MODULE SPECIFICATION

### A3.1 TERMINAL UNIT

#### A3.1.1 Physical

**Dimensions (approx.):** 50 mm wide × 110 mm high

**Weight (approx.):** 0.1kg

#### A3.1.2 Setup Switch

**SW2, segment 1:** Watchdog retry (trip and try again mode)

All other switches are reserved

#### A3.1.3 Link

**LK1 and LK2:** Link pins 1 and 2 for three-wire communications; link pins 2 and 3 for five-wire (see [figure 8](#)).

#### A3.1.4 User Connectors

**Supply power:** Four-way terminal block for supply power. Supply separately monitored by the Controller module.

**Watchdog Relay:** Two × three-way terminal block.

**Backup battery:** Shares connectors with Watchdog relays.

**Modbus:** Two RJ45 sockets, wired in parallel.

**USB:** Type A connector.

#### A3.1.5 USB

**Connector type:** Type A located on controller terminal unit ([Figure 8](#))

**USB standard:** USB 2.0 host communications.

**Source current:** 500 mA max (current limited).

**Fuse:** Within controller module. Non-user replaceable.

## A3.2 CONTROLLER MODULE HARDWARE

### A3.2.1 General

<b>Dimensions:</b>	25mm wide × 114.3mm high × 110mm deep
<b>Flash memory:</b>	128 MByte
<b>File system</b>	Maximum supported filename length is 125 Unicode (UCS16) characters

### A3.2.2 LED Indicators

Power status (24V dc nom — Main supply)

Fault indicator

Battery status

Serial Communications status

Ethernet IP resolution status

PLC program run status

USB software status

USB hardware status

Ethernet speed

Ethernet activity

See [Section 2.3.3](#) for details of all controller module LEDs

### A3.2.3 User Connections

**Ethernet Communications:** RJ45 connector mounted on the underside of the controller unit.

### A3.2.4 Removable Storage

**Memory card:** SDHC 32 MBytes

## A4 I/O MODULE SPECIFICATIONS

Accuracy of analogue I/O is quoted based on the ex-factory calibration. For the E+PLC400, calibration can be improved using the software calibration functionality in the EPLC Standard library's input blocks. For details refer to the CODESYS Online Help (see [section 3.1](#)).

### A4.1 AI2 MODULE

#### General specification, common to all variants:

Power consumption:	2W max.
Common mode rejection (47 to 63 Hz):	> 120dB
Series mode rejection (47 to 63 Hz):	> 60dB
Isolation (channel to channel):	300V RMS or dc (basic insulation).
Isolation (to system):	300V RMS or dc (double insulation).
Max voltage across any channel:	10.3V dc

#### A4.1.1 Thermocouple input variant, AI2-TC

##### mV inputs, Thermocouple inputs

Input range:	-150mV to +150mV
Input impedance:	> 100M $\Omega$ (sensor break detect circuit 'Off')
Input leakage current:	<100nA (sensor break detect circuit 'Off')
mV calibration accuracy:	$\pm 0.1\%$ of input value, max. offset $\pm 10 \mu\text{V}$
Noise:	< 28 $\mu\text{V}$ p-p with filter off: < 4 $\mu\text{V}$ p-p with $\tau = 1.6$ s filter (better with longer time constants).
Resolution:	Better than 2 $\mu\text{V}$ with $\tau = 1.6$ second filter.
Linearity:	Better than 5 $\mu\text{V}$
Temperature coefficient:	< 40 ppm of reading per $^{\circ}\text{C}$
Sensor break protection:	Switchable as 'High', 'low' or 'Off'. Sensor current: 125nA

##### Cold Junction

Temperature range:	-10 $^{\circ}\text{C}$ to +70 $^{\circ}\text{C}$
CJ Rejection:	>30:1
CJ accuracy:	$\pm 0.5$ $^{\circ}\text{C}$ typical (max. offset $\pm 1.0$ $^{\circ}\text{C}$ )
Sensor type:	Pt100 RTD, located beneath the input connector

##### High impedance input (channel two only)

Input range:	0.0V to 1.8V
Input impedance:	>100M $\Omega$ (sensor break detect circuit 'Off')
Input leakage current:	<100nA (sensor break detect circuit 'Off')
Calibration accuracy:	$\pm 0.1\%$ of input value, max. offset $\pm 20 \mu\text{V}$
Noise:	<100 $\mu\text{V}$ p-p with filter off: <15 $\mu\text{V}$ p-p with $\tau = 1.6$ s filter (better with longer time constants).
Resolution:	Better than 7 $\mu\text{V}$ with $\tau = 1.6$ second filter
Linearity:	Better than 50 $\mu\text{V}$
Temperature coefficient:	<40ppm of reading per $^{\circ}\text{C}$

## A4.1.2 DC input variant, AI2-DC

### mV inputs

<b>Input range:</b>	-150mV to +150mV
<b>Input impedance:</b>	> 100M $\Omega$ (sensor break detect circuit 'Off')
<b>Input leakage current:</b>	< 100nA (sensor break detect circuit 'Off')
<b>Calibration accuracy:</b>	$\pm 0.1\%$ of input value, max offset $\pm 10\mu\text{V}$
<b>Noise:</b>	< 28 $\mu\text{V}$ p-p with filter off: < 4 $\mu\text{V}$ p-p with $\tau = 1.6$ s filter (better with longer time constants).
<b>Resolution:</b>	Better than 2 $\mu\text{V}$ with $\tau = 1.6$ second filter
<b>Linearity:</b>	Better than 5 $\mu\text{V}$
<b>Temperature coefficient:</b>	< 40ppm of reading per $^{\circ}\text{C}$
<b>Sensor break protection:</b>	Switchable as 'High', 'low' or 'Off'. Sensor current: 125nA

### High impedance input (channel two only)

<b>Input range:</b>	0.0V to 1.8V
<b>Input impedance:</b>	> 100M $\Omega$ (sensor break detect circuit 'Off')
<b>Input leakage current:</b>	< 100nA (sensor break detect circuit 'Off')
<b>Calibration accuracy:</b>	$\pm 0.1\%$ of input value, max. offset $\pm 20\mu\text{V}$
<b>Noise:</b>	< 100 $\mu\text{V}$ p-p with filter off: < 15 $\mu\text{V}$ p-p with $\tau = 1.6$ s filter (better with longer time constants).
<b>Resolution:</b>	Better than 7 $\mu\text{V}$ with $\tau = 1.6$ second filter.
<b>Linearity:</b>	Better than 50 $\mu\text{V}$
<b>Temperature coefficient:</b>	< 40ppm of reading per $^{\circ}\text{C}$

### Voltage inputs

<b>Input range:</b>	-10.3V to +10.3V
<b>Input impedance:</b>	303k $\Omega$
<b>Calibration accuracy:</b>	$\pm 0.1\%$ of input value, max offset $\pm 2\text{mV}$
<b>Noise:</b>	< 2mV p-p with filter off: < 0.4mV p-p with $\tau = 1.6$ s filter (better with longer time constants).
<b>Resolution:</b>	Better than 0.2mV with $\tau = 1.6$ second filter.
<b>Linearity:</b>	Better than 0.7mV
<b>Temperature coefficient:</b>	< 40ppm of reading per $^{\circ}\text{C}$

### Resistance inputs

<b>Input range:</b>	0 $\Omega$ to 640 $\Omega$ (includes support for 2-, 3- or 4-wire RTD connection)
<b>Calibration accuracy:</b>	$\pm 0.1\%$ of input value, max. offset $\pm 0.5\Omega$
<b>Noise:</b>	< 0.05 $\Omega$ p-p with $\tau = 1.6$ s filter (better with longer time constants).
<b>Resolution:</b>	Better than 0.02 $\Omega$ with $\tau = 1.6$ second filter.
<b>Linearity:</b>	Better than 0.05 $\Omega$
<b>Temperature coefficient:</b>	< 30ppm of reading per $^{\circ}\text{C}$

**High Resistance input**

<b>Input range:</b>	0 to 7k $\Omega$
<b>Calibration accuracy:</b>	$\pm 0.1\%$ of input value, max. offset $\pm 5\Omega$
<b>Noise:</b>	$<0.5\Omega$ p-p with $\tau=1.6$ s filter (better with longer time constants).
<b>Resolution:</b>	Better than $0.2\Omega$ with $\tau=1.6$ second filter.
<b>Linearity:</b>	Better than $0.1\Omega$
<b>Temperature coefficient:</b>	$<30$ ppm of reading per $^{\circ}\text{C}$

**Potentiometer inputs**

<b>Input range:</b>	0 to 100% rotation
<b>End-to-end resistance:</b>	100 $\Omega$ (min.) to 7k $\Omega$ (max.)
<b>Calibration accuracy:</b>	$\pm 0.1\%$ of input value
<b>Noise:</b>	$<0.01\%$ p-p with $\tau=1.6$ s filter (5k $\Omega$ pot.); $<0.3\%$ p-p with $\tau=1.6$ s filter (100 $\Omega$ pot.)
<b>Resolution:</b>	Better than 0.001% with 1.6 second filter and 5k $\Omega$ pot.
<b>Linearity:</b>	Better than 0.01%
<b>Temperature coefficient:</b>	$<20$ ppm of reading per $^{\circ}\text{C}$

**A4.1.3 mA input variant, AI2-MA****4 to 20 mA loop inputs**

<b>Input range:</b>	-25mA to + 25mA with 5 $\Omega$ burden resistor in terminal unit.
<b>Calibration accuracy:</b>	$\pm 0.25\%$ of input value, max. offset $\pm 5\mu\text{A}$
<b>Noise:</b>	$<1\mu\text{A}$ p-p with $\tau=1.6$ s filter (better with longer time constants).
<b>Resolution:</b>	Better than $0.5\mu\text{A}$ with $\tau=1.6$ second filter
<b>Linearity:</b>	Better than $1\mu\text{A}$
<b>Temperature coefficient:</b>	$<50$ ppm of reading per $^{\circ}\text{C}$



## A4.2 AI3 MODULE

### A4.2.1 General specification

Power consumption (Current i/p):	2.2W
Power consumption (Three powered loops):	1.5W max.
Common mode rejection (47 to 63Hz):	> 120dB
Series mode rejection (47 to 63Hz):	>60dB
Isolation (Channel to channel):	50V RMS or dc (basic insulation).
Isolation (to system):	300V RMS or dc (double insulation).

### A4.2.2 Hart Compliance

Cutting printed circuit links (one per channel) on the underside of the terminal unit places 195 $\Omega$  resistors in the input circuits within the AI3 module ([section 2.3.5](#)).

### A4.2.3 Channel inputs

Input range:	-28mA to +28mA
Calibration accuracy:	$\pm 0.1\%$ of input value, max. offset $\pm 20\mu\text{A}$
Noise:	$< 1\mu\text{A}$ p-p with $\tau = 1.6\text{s}$ filter (better with longer time constants)
Resolution:	Better than $0.5\mu\text{A}$ with $\tau = 1.6$ second filter.
Linearity:	Better than $1\mu\text{A}$
Temperature coefficient:	$< 50\text{ppm}$ of reading per $^{\circ}\text{C}$
Burden resistor:	$60\Omega$ nominal; 50mA maximum current
Channel PSU:	22V (min at 21mA) to 30V (max) at 4mA
PSU protection:	30mA (nom) current trip, auto resetting.

### A4.3 AI4 MODULE

#### General specification (applies to all AI4 variants)

Power consumption:	2W max.
Common mode rejection (47 to 63Hz):	> 120dB
Series mode rejection (47 to 63Hz):	> 60dB
Isolation (Channel 1 to channel 2):	No isolation
Isolation (Channel 3 to channel 4):	No isolation
Isolation (Ch1 or Ch2 to Ch3 or Ch4):	300V RMS or dc (basic insulation).
Isolation (to system):	300V RMS or dc (double isolation).
Max. voltage across any channel:	5V dc

#### A4.3.1 Thermocouple input variant

##### Thermocouple inputs

Input range:	-150mV to +150mV
Input impedance:	>20M $\Omega$
Input leakage current:	<125nA
Calibration accuracy:	$\pm 0.1\%$ of input value, max. offset $\pm 10\mu\text{V}$
Noise:	<4 $\mu\text{V}$ p-p with $\tau=1.6$ s filter (better with longer time constants).
Resolution:	Better than 2 $\mu\text{V}$ with $\tau=1.6$ second filter.
Linearity:	Better than 5 $\mu\text{V}$
Temperature coefficient:	<40ppm of reading per $^{\circ}\text{C}$
Sensor break protection:	Fixed pull-up. Sensor current: 125nA

##### Cold Junction

Temperature range:	-10 $^{\circ}\text{C}$ to +70 $^{\circ}\text{C}$
CJ rejection:	>30:1
CJ accuracy:	$\pm 0.5$ $^{\circ}\text{C}$ typical, max. offset $\pm 1$ $^{\circ}\text{C}$
Sensor type:	Pt100 RTD, located beneath the input connector.

#### A4.3.2 mV input variant

Input range:	-150mV to +150mV
Input impedance:	>20M $\Omega$ (sensor break detect circuit 'Off')
Input leakage current:	<125nA (sensor break detect circuit 'Off')
Calibration accuracy:	$\pm 0.1\%$ of measured value $\pm 10\mu\text{V}$
Noise:	<4 $\mu\text{V}$ p-p with $\tau=1.6$ s filter (better with longer time constants).
Resolution:	Better than 2 $\mu\text{V}$ with $\tau=1.6$ second filter.
Linearity:	Better than 5 $\mu\text{V}$
Temperature coefficient:	<40ppm of reading per $^{\circ}\text{C}$

### A4.3.3 mA input variant

<b>Input range:</b>	-25mA to +25mA
<b>Calibration accuracy:</b>	±0.25% of input value, max. offset ±0.5µA
<b>Noise:</b>	< 1µA p-p with τ=1.6 s filter (better with longer time constants).
<b>Resolution:</b>	Better than 0.5µA with τ=1.6 second filter.
<b>Linearity:</b>	Better than 1µA
<b>Temperature coefficient:</b>	<50ppm of reading per °C
<b>Burden resistor:</b>	5Ω ± 1% (fitted to terminal unit)

## A4.4 AI8 MODULE

### General specification (applies to all AI8 variants)

Number of channels:	8 (4 for RTD)
Module power consumption:	< 1.8W
Common mode rejection (47 to 63Hz) w.r.t. system, i.e. across galvanic isolation:	> 140dB
Series mode rejection (47 to 63Hz):	> 60dB
Isolation to system:	Reinforced for < 300V ac/dc mains networks—Installation category II
Isolation between channels:	Galvanic isolation in pairs. Basic isolation for < 300V ac/dc mains networks—Installation category II . Differential isolation within $\pm 1$ V range between the two channels of each pair in thermocouple, mV and mA modules. RTD provides basic isolation (< 300V ac/dc) between channels.

### A4.4.1 Thermocouple input variant

#### Thermocouple inputs

Suitable thermocouples:	B, C, D, E, G2, J, K, L, N, R, S, T, U, NiMo/NiCo, Platinel, Ni/NiMo, Pt20%Rh/Pt40%Rh
Input range:	-80mV to +80mV
Input impedance:	10M $\Omega$ differential, 2.5M $\Omega$ common
Input leakage current:	< $\pm 25$ nA (@ < 1V common)
Calibration accuracy:	$\pm 0.1\%$ of reading above 10% of range (full ambient temperature span)
DC common mode rejection (w.r.t. other channels of the same pair):	> 105dB for source impedance mismatch < 100 $\Omega$
Resolution/Noise (at 110ms update rate):	> 17 bits of span with $\tau=1.6$ s filter ( $\pm 1.5\mu$ V); 16 bit of span with no filter ( $\pm 3\mu$ V)
Linearity:	$\pm 0.1$ °C (deviation from defined curves)
Sensor break detection:	within 250ms using 25 $\mu$ A pulse. Thresholds equivalent to 50k $\Omega$ (high).

#### Cold Junction

CJ Rejection:	> 30:1 minimum
Internal CJ accuracy:	$\pm 0.8$ °C typical

### A4.4.2 mV input variant

Suitable transmitter types:	mV sources with output impedance > 1 k $\Omega$ (floating or grounded)
Input range:	-80mV to +80mV
Input impedance:	10M $\Omega$ differential, 2.5M $\Omega$ common
Input leakage current:	< $\pm 25$ nA (@ < 1V common)
Calibration accuracy:	$\pm 0.1\%$ of reading above 10% of range (full ambient temperature span)
DC common mode rejection (w.r.t. other channels of the same pair):	> 105dB for source impedance mismatch < 100 $\Omega$
Resolution/Noise:	> 17 bit with $\tau=1.6$ s filter ( $\pm 1.5\mu$ V); 16 bit of span with no filter ( $\pm 3\mu$ V)
Linearity:	10ppm of span
Temperature coefficient:	< $\pm 30$ ppm per °C
Zero offset:	< $\pm 3\mu$ V
Offset drift:	< 20pV per °C
Sensor break detection:	within 250ms using 25 $\mu$ A pulse. Thresholds equivalent to 50k $\Omega$ (high).

### A4.4.3 mA input variant

<b>Suitable transmitter types:</b>	4 to 20mA sensors (floating or grounded)
<b>Input range:</b>	-20mA to +20mA with 3.33 $\Omega$ burden resistor fitted in the terminal unit.
<b>Input impedance:</b>	10M $\Omega$ differential, 2.5M $\Omega$ common
<b>Calibration accuracy:</b>	$\pm 0.15\%$ of reading above 10% of range (full ambient temperature span)
<b>DC common mode rejection (w.r.t. other channels of the same pair):</b>	> 105dB for source impedance mismatch < 100 $\Omega$
<b>Resolution/Noise:</b>	> 17 bit with $\tau=1.6$ s filter ( $\pm 0.5\mu$ V); 16 bit of span with no filter ( $\pm 1.0\mu$ V)
<b>Linearity:</b>	20ppm of span
<b>Temperature coefficient:</b>	< $\pm 40$ ppm per $^{\circ}$ C (using 10ppm shunt resistor)
<b>Zero offset:</b>	< $\pm 1\mu$ A
<b>Offset drift:</b>	< $\pm 8$ pA per $^{\circ}$ C
<b>Sensor break detection:</b>	Not detectable in hardware (software can detect under range current)

### A4.4.4 RTD input variant

<b>Number of channels</b>	4
<b>Suitable RTD types:</b>	Pt100, Pt1000
<b>Input ranges:</b>	0 $\Omega$ to 500 $\Omega$ and 0 $\Omega$ to 5k $\Omega$
<b>Calibration accuracy:</b>	$\pm 0.1\%$ of resistance reading above 10% of range (full ambient temperature span).
<b>Resolution/Noise:</b>	>17 bit ( $\pm 8$ m $\Omega$ ) (with $\tau=1.6$ s filter); 16 bit ( $\pm 16$ m $\Omega$ ) with no filter
<b>Linearity:</b>	20ppm of span
<b>Temperature coefficient:</b>	< $\pm 20$ ppm per $^{\circ}$ C
<b>Sensor break detection:</b>	within 125ms by high resistance detection

## A4.5 AO2 MODULE

### A4.5.1 General specification

Power consumption:	2.2W max.
Isolation (Channel to channel):	300V RMS or dc (basic insulation).
Isolation (to system):	300V RMS or dc (double insulation).

### A4.5.2 Current outputs

Output range:	-0.1 to +20.5mA
Load limits:	0 to 500 $\Omega$
Calibration accuracy:	Better than $\pm 0.1\%$ of reading, max. offset $\pm 20\mu\text{A}$
Linearity:	0.03% range (0.7 $\mu\text{A}$ )
Resolution:	Better than 0.5 $\mu\text{A}$ with $\tau = 1.6$ second filter.

### A4.5.3 Voltage outputs

Output load limit (-0.1 to +10.1V range):	550 $\Omega$ min.
Output load limit (-0.3V to +10.3V range):	1500 $\Omega$ min.
Calibration accuracy:	Better than 0.1% of reading, max. offset $\pm 10\text{mV}$
Linearity:	0.03% range (0.3mV)
Resolution:	Better than 1 part in 10,000 (0.5mV typical)

## A4.6 DI6 MODULE



Note: This module is ordered either as a 115V version or as a 230V version. One type cannot be converted into the other.

Each input is fitted with a 470pF capacitor for EMC purposes. This causes an earth leakage current of approximately 0.04mA at 115V ac 60Hz or 0.08mA 230V ac 60Hz.

### General specification

Power consumption:	0.5W max.
Detectable pulse width:	Three mains cycles
Isolation (Channel to system):	300V RMS or dc (Double insulation)
Isolation (Channel to channel):	300V RMS or dc (Basic insulation)

#### A4.6.1 115V ac input variant: 115V inputst

Off (logic 0) voltage:	0 to 35V ac.
On (logic 1) voltage:	95V to 150V ac
Maximum input current:	8mA at 150V RMS
Minimum input current:	2mA
Max. voltage across any channel:	150V RMS

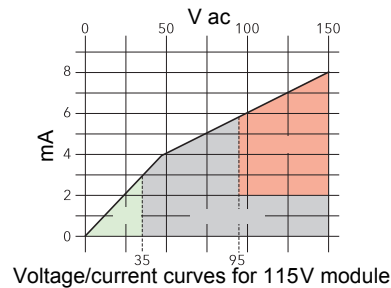

Note: The result of applying RMS voltages between 35V and 95V is not defined.

#### A4.6.2 230V ac input variant: 230V inputs

Off (logic 0) voltage:	0 to 70V ac.
On (logic 1) voltage:	180V to 264V ac
Maximum input current:	9mA at 264V RMS
Minimum input current:	2mA
Max. voltage across any channel:	264V RMS

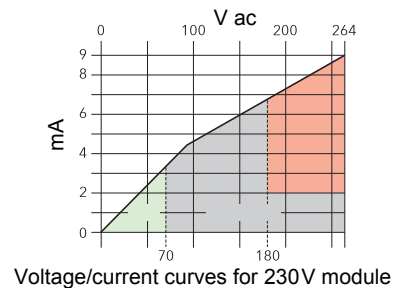

Note: The result of applying RMS voltages between 70 V and 180 V is not defined.

## A4.7 DI 16 MODULE

### A4.7.1 General specification

Power consumption (logic mode):	0.75W max.
Power consumption (contact mode):	2.0W max.
Isolation (Channel to system):	300V RMS or dc (Double insulation).
Isolation (Channel to channel):	Channels share 'common' ('C') connections.
Minimum pulse width:	78.125ms
Max. voltage across any channel:	30V dc

### A4.7.2 Logic inputs

Off (logic 0) voltage:	-30V to +5V dc
On (logic 1) voltage:	10.8V to 30V dc
Input current:	3.8mA approx. at 12Vdc; 2.8mA approx. at 24V dc.

### A4.7.3 Contact inputs

Off (logic 0) resistance:	> 7 k $\Omega$
On (logic 1) resistance:	< 1 k $\Omega$
Wetting current:	4mA min.
Module internal isolated power supply (terminal P voltage):	16 to 18V dc
Wetting voltage (effective):	12V dc min.



## A4.8 DO16 MODULE



Note: Refer to [section 2.3.10](#) for precautions to be taken when fitting DO16 modules

### A4.8.1 General specification

<b>Max. Power consumption (Module):</b>	0.6W
<b>Max. Power consumption (plant side):</b>	850W
<b>Isolation (Channel to system):</b>	300V RMS or dc (Double insulation).
<b>Isolation (Channel to channel):</b>	Channels share 'common' ('C') connections.

### A4.8.2 Output specification

<b>Voltage supply (<math>V_{CS}</math>):</b>	24V dc $\pm 20\%$
<b>Logic 1 output voltage:</b>	$(V_{CS} - 1)V$ for a full load.
<b>Logic 0 output voltage:</b>	<1V
<b>Logic 1 output current:</b>	0.7A max. per channel.
<b>Logic 0 output current:</b>	10 $\mu$ A
<b>Short circuit protection:</b>	0.7 to 1.7A per channel
<b>Module thermal cut-off (55 °C ambient):</b>	90 $\pm 3$ °C (restart at 88 $\pm 3$ °C )

## A4.9 RLY8 MODULE



Note: Each input is fitted with a 100pF capacitor for EMC purposes. For each relay, this causes an earth leakage current of approximately 0.02mA at 240Vac 60 Hz.

### A4.9.1 General specification

<b>Power consumption:</b>	2.5W max.
<b>Isolation (Channel to system):</b>	300V RMS or dc (Double insulation).
<b>Isolation (Channel to channel):</b>	300V RMS or dc (Basic insulation).
<b>Contact life (resistive load) 240Vac, 2A:</b>	$>6 \times 10^5$ operations
<b>Contact life (resistive load) 240Vac, 1A:</b>	$>10^7$ operations
<b>Contact life (inductive load)</b>	As per derating curves
<b>Mechanical life:</b>	$>3 \times 10^7$ operations

### A4.9.2 Relay specification

<b>Contact material:</b>	AgCdO
<b>Contact format:</b>	Common and normally open contacts. (Open circuit with relay not energised).
<b>Maximum current rating (ac input):</b>	2A at up to 240Vac
<b>Maximum current rating (dc input):</b>	2A at 50Vdc decreasing linearly to 0.5A at 200 V dc
<b>Minimum current rating:</b>	100mA at 12V

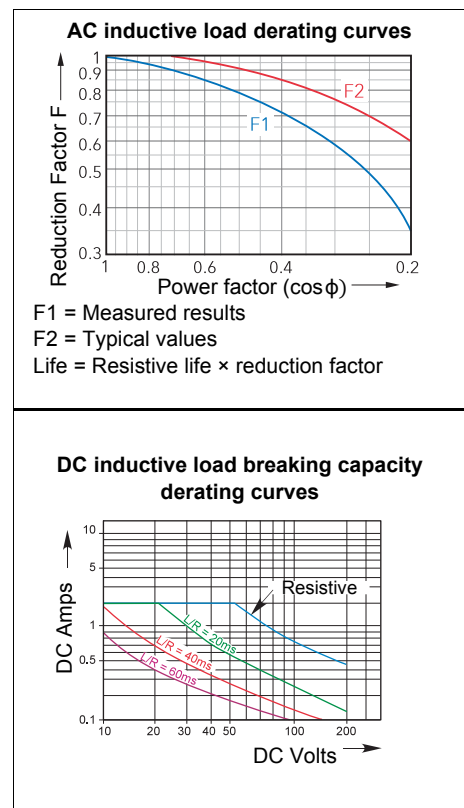

## A4.10 ZI Zirconia Input Module

### A4.10.1 General specification

Power consumption:	1.8W max
Common mode rejection:	>80dB (48 to 62Hz)
Series mode rejection:	>60dB (48 to 62Hz)
Isolation (ZI Channel to TC channel):	300V RMS or dc (Basic insulation).
Isolation (Channel to system):	300V RMS or dc (Double insulation).
Max. voltage across any channel:	10V dc

### A4.10.2 Thermocouple input (channel 1)

Input range:	-77mV to +100mV
Input impedance:	10M $\Omega$
Calibration accuracy:	$\pm 0.1\%$ of reading $\pm 10\mu\text{V}$
Noise:	$< 5\mu\text{V}$ peak-to-peak with $\tau=1.6\text{ s}$ filter.
Resolution:	Better than $2\mu\text{V}$ with $\tau=1.6\text{ s}$ filter.
Linearity:	$\pm 0.1\text{ }^\circ\text{C}$
Temperature coefficient:	$< \pm 30\text{ ppm}/^\circ\text{C}$
Sensor break protection:	250nA break high, low or off

### Cold Junction

Temperature range:	$-10\text{ }^\circ\text{C}$ to $+70\text{ }^\circ\text{C}$
CJ rejection:	$>30:1$
CJ accuracy:	$\pm 0.5\text{ }^\circ\text{C}$ (typical); $\pm 1.3\text{ }^\circ\text{C}$ max. (automatic CJC)
Sensor type:	Pt100 RTD, located beneath the input connector.

### A4.10.3 Zirconia input (channel 2)

Input range:	0mV to +1800mV
Input impedance:	$>500\text{ M}\Omega$
Calibration accuracy:	$\pm 0.2\%$ of input
Noise:	$< 0.1\text{ mV}$ peak-to-peak with $\tau=1.6\text{ s}$ filter.
Resolution:	$< 50\mu\text{V}$ with $\tau=1.6\text{ s}$ filter.
Sensor impedance measurement:	0.1k $\Omega$ to 100k $\Omega$ $\pm 2\%$
Input leakage current:	$\pm 1\text{ nA}$ (typical) $\pm 4\text{ nA}$ (max.)

This page is intentionally blank

## Appendix B: E+PLC400 Battery Replacement Procedure

<b>Personnel</b>	One engineer, who shall be a suitably qualified person.
<b>Time required to complete</b>	10 minutes.
<b>Parts required</b>	Battery board (contains battery, soldered onto the board) Order Code E+PLC400SPARES/ACCESS/XX/XX/XX/BATT/XX For sales contacts see <a href="http://www.eurotherm.com/global">www.eurotherm.com/global</a>
<b>Tools required</b>	Magnetized Pozidrive #1 Screwdriver
<b>When to carry out</b>	If the controller module battery LED (labelled with an $\oplus$ icon) goes out, or every 12 months, whichever is sooner.

The E+PLC400 contains a 3V 'coin-cell' style battery, mounted on small board, fitted on the inside of the plastic side panel adjacent to the controller module.

The purpose of the battery is to maintain the contents of the controller module terminal unit's volatile memory when the E+PLC400 is powered off. This memory stores various parameters including the unit's serial number.



Note: The E+PLC400 can be left powered up while the battery is being replaced. This ensures the volatile memory contents will be retained.

The battery is soldered to its board, and the two are replaced as a single unit. Proceed as follows:

1. Open the hinged plastic front cover of the E+PLC400, so that the terminal units can be seen.
2. Locate the back of battery board (Figure 39): It is on the inside of the plastic side panel to the left of the controller module, and is fixed in place by two screws. A two-wire cable runs from the front of the battery board to the controller module terminal unit; the red wire connects to the **B+** terminal, the black wire connects to the **B-** terminal. Eurotherm recommends leaving these wires connected to the terminals whilst replacing the battery.

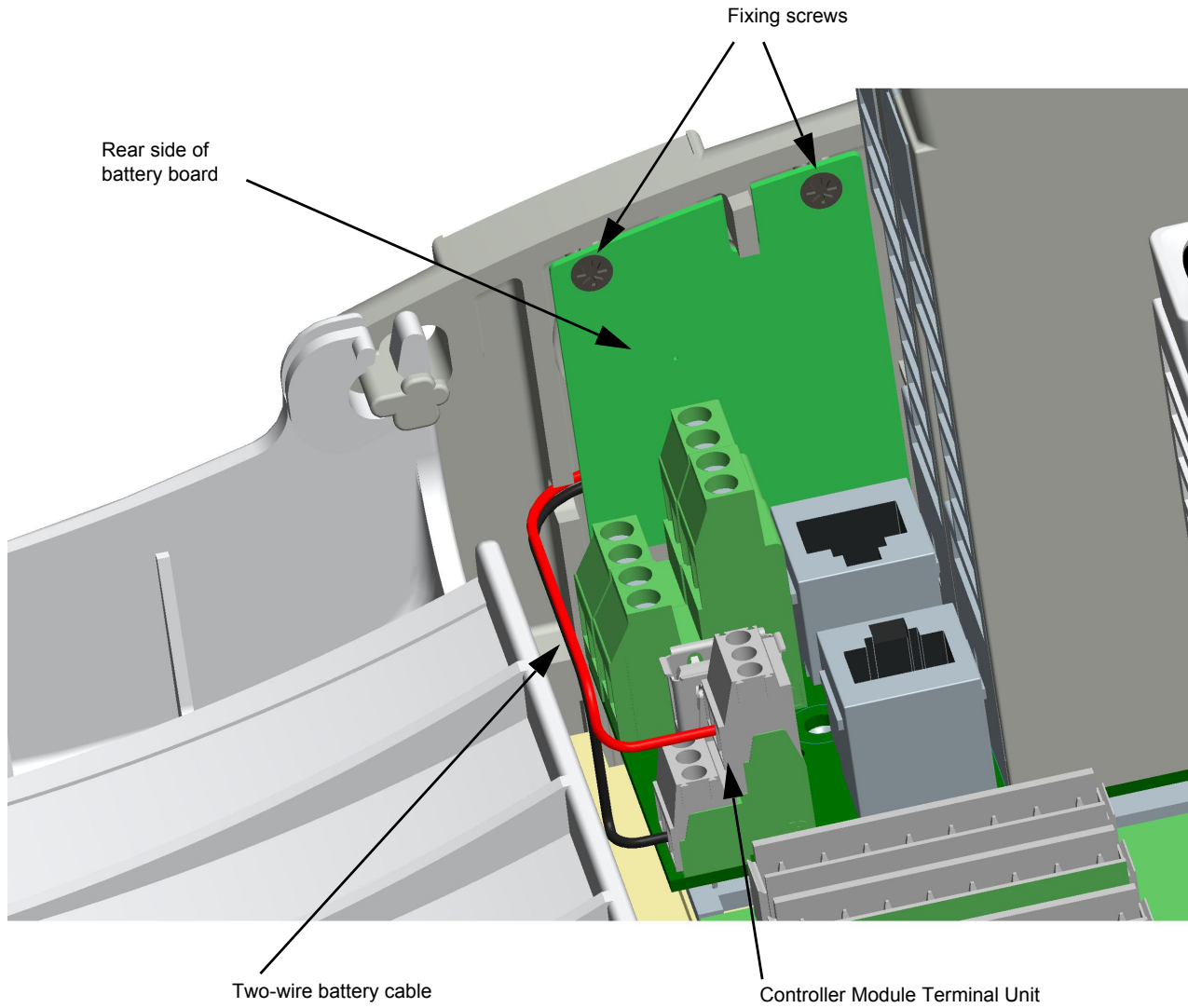

Figure 39: Battery board in place

- Using a magnetized Pozidrive #1 screwdriver, unscrew the two fixing screws holding the battery board in place.
- Carefully manoeuvre the battery board out from the plastic side panel. Unplug the two-wire cable from the board end (Figure 40)..

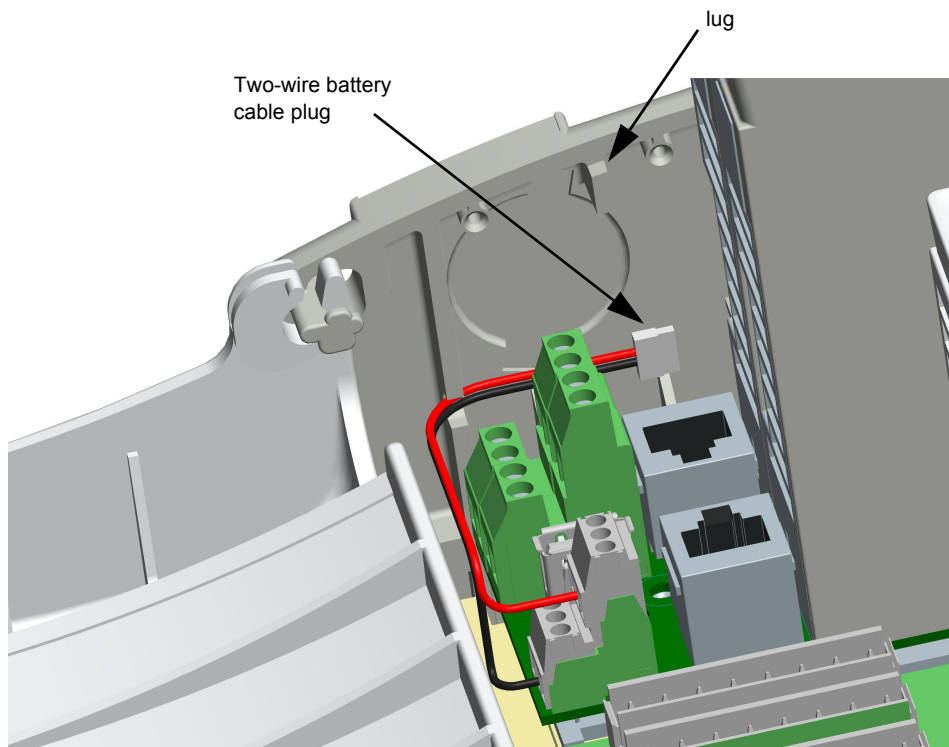

Figure 40: Battery board removed



**Warning:** Do not touch the battery itself using metal pliers or tweezers, as this could cause a short circuit possibly resulting in an explosion of the battery.



**Warning:** If the E+PLC400 is powered off during the battery change procedure, ensure that the new battery is connected within one hour of disconnecting the old battery. If the battery is disconnected for longer than one hour, the content of the controller module memory is likely to be erased or corrupted.

5. Take the new battery board (Figure 41), and plug the two-wire battery cable into it. |

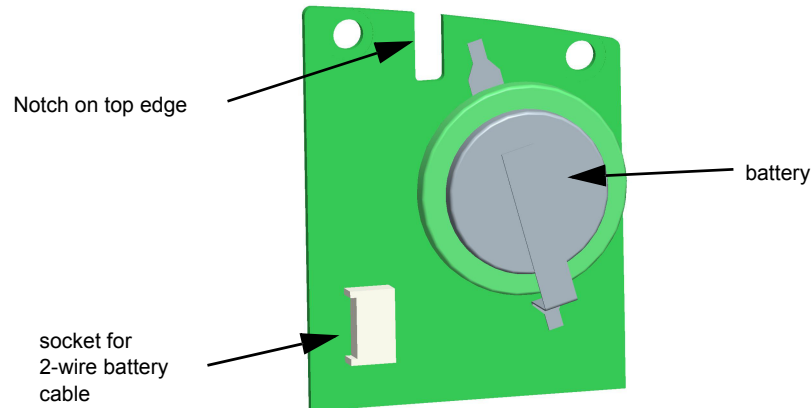

Figure 41: New battery board

6. Manoeuvre the new battery board into position in the left-hand plastic side panel. Note the lug on the panel which fits into the notch on the top end of the battery board.
7. Using a magnetized Pozidrive #1 screwdriver, screw in the two fixing screws to hold the battery board in place.
8. Close the plastic top cover of the E+PLC400.
9. Ensure the old battery board is disposed of appropriately.



## Appendix C: E+HMI150 Panel Configuration

The E+HMI150 panels are intended for use with the E+PLC400.

From time to time upgrades may be available. These may be downloaded from [www.eurotherm.com/ehmi](http://www.eurotherm.com/ehmi).

Configuration means:

- Setting the IP address
- Loading the settings for the HMI

### C1 Connections

Connect the panel to external equipment in accordance with your particular set up.

Figure 42 shows an example for a local connection. A PC may be connected if it is considered of extra help.

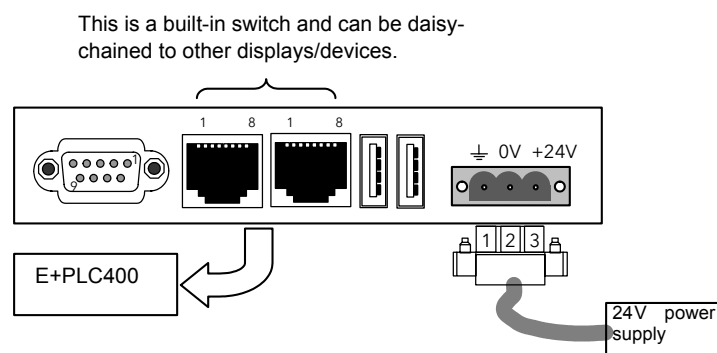

Figure 42: Example E+HMI150 panel connection

### C2 Procedure

1. Switch on.
2. The panel will normally boot up into the 'Main OS', however, network configuration needs to be carried out in the 'Configuration OS'. To enter this mode, at the instant of power up, tap the E+HMI150 screen rapidly and repeatedly until a message `Tap Tap is Detected – Going to Config Mode` appears. This is followed by the Systems Settings tool (Figure 43) — this may take several seconds.
3. Tap `Next` (or `Back`) until `Network` is shown.

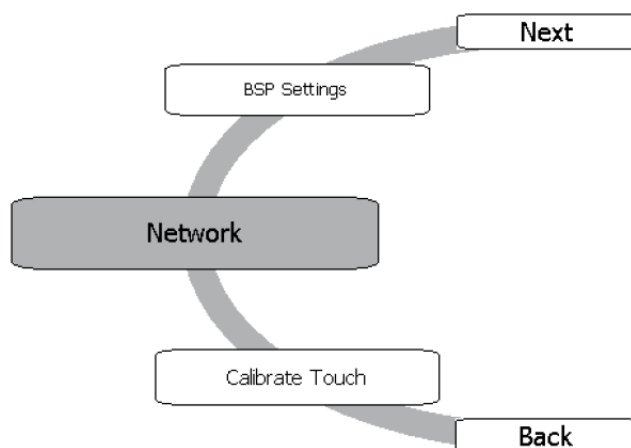

Figure 43: System Settings tool

### C3 Set up the IP address

1. Tap on `Network`. A window appears which allows an IP address to be entered.
2. The default is `Obtain an IP address via DHCP`. For the network example shown here select `Specify an IP Address`.
3. Tap into the IP address, this opens a keyboard on the E+HMI150 screen. Enter a valid IP address either through the E+HMI150 screen or it may be found more convenient to use an external keyboard.
4. It may only be necessary to enter a Gateway address if an external router is used in your particular system.
5. Tap `OK`. An error message, `Invalid IP Address`, may appear if a Gateway address has not been entered. This may be accepted by pressing `OK`.
6. Press `Back` (or `Next`) to select `Restart`. A `Restart` pop up window gives the choice to restart `Main OS`, `Configuration OS` or `Force Restart`. Select `Main OS` and click `OK`.

### C4 Import/Export 'RemoteVisu' Configuration file to/from the E+HMI150

The configuration file is copied to a memory stick for editing and then copied back to the E+HMI150.

#### C4.1 Preparing a USB memory stick

The following steps are carried out on a PC.

1. Select a USB memory stick with FAT32 format.
2. Using a text editor such as Notepad create the following line:  

```
cmd /C \Flash\RemoteVisu\import_export.bat
```
3. Save the text file with the name `autoexec.bat` on the root directory of the USB memory stick. (Make sure that system files can be viewed). The memory stick may now be safely unplugged.

Note: Note: The memory stick must not contain any other configuration files in the RemoteVisu folder.

#### C4.2 Carrying out the Import/export process

1. Start E+HMI150 and wait until it is booted into the HMI application, for example, `CODESYSRemoteVisu-WinCEV3`.



Note: error messages will be shown if the panel is not configured/connected to the E+PLC400.

2. Plug the USB memory stick into the E+HMI150 panel. The import/export process will start automatically. Since no configuration file is found, the current configuration is copied from the E+HMI150 to the memory stick. The message shown here is displayed:

```
Version 0.1
RemoteVisu Import/Export utility .....
.....
-----
Exporting RemoteVisu configuration file...
RemoteVisu configuration file exported correctly to
\USBMemory\RemoteVisu\CodesysControl.cfg.
Press any key to continue..
```

3. Close the window. Use `File > Close` or `X` in the top right hand corner of the E+HMI150 or any key on the keyboard.

4. The configuration file (`CodesysControl.cfg`) is now exported to the USB memory stick, which can now be safely unplugged. The file can be modified on a PC using a text editor. This file is stored in the following location of the USB memory stick:

```
\RemoteVisu\CodesysControl.cfg
```

5. Using the text editor, open the file to edit the three lines shown here.

```
Communication.TcpAddressDest  set the IP address of the E+PLC400.
VisuClient.VisuAppName       set the application name of the CODESYS project.
VisuClient.StartVisu         set the specific visualisation screen which is displayed on start up.
```

```
[CmpVisuHandlerRemote]
Communication.TcpAddressDest=192.168.111.222
Communication.TcpAddressDestPort=-1

;Communication.AddressDest=
;Communication.PlcNameDest=N01H0001

VisuClient.VisuAppName=Application
VisuClient.StartVisu=Visualization

;VisuClient.BestFit=1
;Credentials.UserName=
;Credentials.Password=
;VisuClient.AntiAliasing=
```

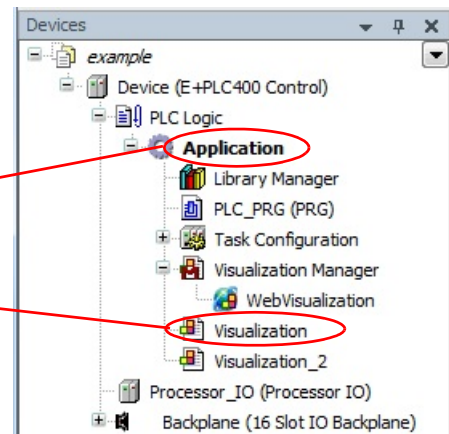

Figure 44: Example CodesysControl.cfg



Note: the configuration file is saved in the exact same location of the USB memory stick as below `\RemoteVisu\CodesysControl.cfg`

6. Make sure that the E+HMI150 panel is running the RemoteVisu application.
7. Plug the USB memory stick back into the E+HMI150 panel. The import/export process of the configuration file is started automatically.
8. This utility executes the following:
- Backs up the current configuration file found on the E+HMI150 onto the memory stick.
  - Copies the new configuration file from memory stick to the of the E+HMI150.
- This message is displayed:
- ```
A new RemoteVisu config file has been detected...
- Backuping-up current config file to
  \USBMemory\RemoteVisu\CodesysControl.cfg.bak
- Importing the new RemoteVisu configuration file...
- Copy completed.
- Please unplug the USB stick and restart the HMI panel to start
  RemoteVisu with the new config file.
Press any key to continue
```
9. Once the import is complete, close the window and safely unplug the memory stick.
10. Close the RemoteVisu application, using the `Commands > Shutdown` menu or power cycle the panel. The application will then restart with the new configuration file.
11. If the settings are correct then RemoteVisu should find the E+PLC400 in the network and display the correct visualisation.

This page is intentionally blank

## Index

### Numerics

|                                    |    |
|------------------------------------|----|
| 16-channel digital i/p module      |    |
| Pinout and status indicators ..... | 32 |
| Specification .....                | 54 |
| 16-channel digital o/p module      |    |
| Pinout and status indicators ..... | 30 |
| 3-wire/5-wire selection .....      | 13 |

### A

|                                    |    |
|------------------------------------|----|
| AI2 module                         |    |
| Pinout and status indicators ..... | 18 |
| Specification .....                | 44 |
| AI3 module                         |    |
| Pinout and status indicators ..... | 20 |
| Specification .....                | 47 |
| AI4 module                         |    |
| Pinout and status indicators ..... | 22 |
| Specification .....                | 48 |
| AO2 module                         |    |
| Pinout and status indicators ..... | 27 |
| Specification .....                | 52 |
| archiving .....                    | 3  |

### B

|                   |    |
|-------------------|----|
| Backplane .....   | 8  |
| Mounting .....    | 8  |
| Battery           |    |
| Replacement ..... | 59 |
| battery .....     | 59 |

### C

|                                   |    |
|-----------------------------------|----|
| CE compliance .....               | 33 |
| Change battery procedure .....    | 59 |
| CODESYS Development System .....  | 35 |
| Connections and Wiring            |    |
| DC supply wiring .....            | 13 |
| Controller module                 |    |
| Module specification .....        | 43 |
| Terminal unit specification ..... | 42 |

### D

|                                    |    |
|------------------------------------|----|
| DI16 module                        |    |
| Pinout and status indicators ..... | 32 |
| Specification .....                | 54 |
| DI6 module                         |    |
| Specification .....                | 53 |
| DO16 module                        |    |
| Pinout and status indicators ..... | 30 |

### E

|                                   |    |
|-----------------------------------|----|
| earth leakage .....               | 56 |
| Eight-channel relay output module |    |
| Pinout .....                      | 33 |
| Specification .....               | 56 |

|                               |       |
|-------------------------------|-------|
| Electrical installation ..... | 13    |
| EMC .....                     | 2, 56 |
| Ethernet .....                | 17    |

### F

|                                    |    |
|------------------------------------|----|
| Four-channel analogue i/p module   |    |
| Pinout and status indicators ..... | 22 |
| Specification .....                | 48 |
| fuses .....                        | 15 |

### H

|                          |    |
|--------------------------|----|
| Hardware                 |    |
| Panel installation ..... | 5  |
| Unpacking .....          | 4  |
| HART compatibility ..... | 21 |
| help, online .....       | 35 |

### I

|                  |    |
|------------------|----|
| Installation     |    |
| Electrical ..... | 13 |
| Mechanical       |    |
| Procedure .....  | 5  |
| interlocks ..... | 16 |
| Isolation .....  | 2  |

### J

|                 |   |
|-----------------|---|
| July 2014 ..... | i |
|-----------------|---|

### L

|                      |    |
|----------------------|----|
| Label symbols .....  | 2  |
| LED                  |    |
| Interpretation ..... | 17 |

### M

|                               |    |
|-------------------------------|----|
| Mechanical installation ..... | 5  |
| Module                        |    |
| Installation .....            | 10 |
| Mounting the backplane        |    |
| DIN rail .....                | 8  |

### O

|                   |    |
|-------------------|----|
| online help ..... | 35 |
|-------------------|----|

### P

|                                       |    |
|---------------------------------------|----|
| Panel mounting .....                  | 8  |
| Physical structure .....              | 3  |
| Pinout                                |    |
| AI2 module .....                      | 18 |
| AI3 module .....                      | 20 |
| AI4 module .....                      | 22 |
| AO2 module .....                      | 27 |
| Controller module .....               | 13 |
| DI16 module .....                     | 32 |
| DO16 module .....                     | 30 |
| RJ45 .....                            | 15 |
| RLY8 module .....                     | 33 |
| platinum resistance thermometer ..... | 24 |
| Pollution                             |    |
| Pollution degree 2 .....              | 39 |
| Power Supply                          |    |

|                                       |                        |                              |        |
|---------------------------------------|------------------------|------------------------------|--------|
| DC Wiring .....                       | 13                     | <b>U</b>                     |        |
| Power supply .....                    | 3                      | Unpacking the hardware ..... | 4      |
| <b>R</b>                              |                        | USB                          |        |
| RFI .....                             | 15                     | Connector location .....     | 13     |
| RJ45 connectors .....                 | 15                     | USB connector .....          | 15     |
| RJ45 pinout .....                     | 15                     | <b>W</b>                     |        |
| RLY8 module                           |                        | Watchdog .....               | 13     |
| Pinout and status indicators .....    | 33                     | watchdog .....               | 16, 42 |
| Specification .....                   | 56                     | Watchdog Reset .....         | 1      |
| RoHS .....                            | iii, 2                 | Wiring                       |        |
| <b>S</b>                              |                        | Controller module .....      | 13     |
| safety earth .....                    | 14                     | Electrical .....             | 13     |
| Safety notes .....                    | 1                      | <b>Z</b>                     |        |
| screwdriver .....                     | 20, 22, 27, 32, 33, 59 | zirconia probe .....         | 34     |
| Six-channel digital i/p module        |                        |                              |        |
| Specification .....                   | 53                     |                              |        |
| Specification .....                   | 39                     |                              |        |
| AI3 module .....                      | 47                     |                              |        |
| AI4 module .....                      | 44, 48                 |                              |        |
| AO2 module .....                      | 52                     |                              |        |
| Controller Module .....               | 42                     |                              |        |
| DI16 module .....                     | 54                     |                              |        |
| DI6 module .....                      | 53                     |                              |        |
| RLY8 module .....                     | 56                     |                              |        |
| Status                                |                        |                              |        |
| Indicators                            |                        |                              |        |
| AI2 module .....                      | 19                     |                              |        |
| AI3 module .....                      | 20                     |                              |        |
| AI4 module .....                      | 23                     |                              |        |
| AO2 module .....                      | 28                     |                              |        |
| DI16 module .....                     | 32                     |                              |        |
| RLY8 module .....                     | 33                     |                              |        |
| Supply Voltage .....                  | 13                     |                              |        |
| Wiring .....                          | 13                     |                              |        |
| Symbols used on labels .....          | 2                      |                              |        |
| <b>T</b>                              |                        |                              |        |
| Technical specification .....         | 39                     |                              |        |
| Terminal unit installation .....      | 9                      |                              |        |
| thermocouples .....                   | 18, 22                 |                              |        |
| Three-channel analogue i/p module     |                        |                              |        |
| Pinout and status indicators .....    | 20                     |                              |        |
| Specification .....                   | 47                     |                              |        |
| Tightening torque (terminals) .....   | 14                     |                              |        |
| tutorials .....                       | 37                     |                              |        |
| Two-channel analogue i/p (AI2) module |                        |                              |        |
| Pinout and status indicators .....    | 18                     |                              |        |
| Two-channel analogue i/p module       |                        |                              |        |
| Specification .....                   | 3, 44                  |                              |        |
| Two-channel analogue o/p (AO2) module |                        |                              |        |
| Pinout and status indicators .....    | 27                     |                              |        |
| Two-channel analogue o/p module       |                        |                              |        |
| Specification .....                   | 52                     |                              |        |

This page is intentionally blank

---

**Eurotherm Limited**

Faraday Close  
WORTHING  
BN13 3PL  
UK

TEL +44 1903 268500  
FAX +44 1903 265982

[www.eurotherm.com/worldwide](http://www.eurotherm.com/worldwide)



Scan for  
local contacts

Eurotherm by Schneider Electric, the Eurotherm logo, Chessell, EurothermSuite, Mini8, Eycon, Eyris, EPower, EPack, nanodac, piccolo, versadac, optivis, Foxboro and Wonderware are trademarks of Schneider Electric, its subsidiaries and affiliates. All other brands may be trademarks of their respective owners.

All rights are strictly reserved. No part of this document may be reproduced, modified, or transmitted in any form by any means, nor may it be stored in a retrieval system other than for the purpose to act as an aid in operating the equipment to which the document relates, without the prior written permission of Eurotherm Limited.

Eurotherm Limited pursues a policy of continuous development and product improvement. The specifications in this document may therefore be changed without notice. The information in this document is given in good faith, but is intended for guidance only.

Eurotherm Limited will accept no responsibility for any losses arising from errors in this document.